

# Panasonic®



## Operating Instructions Digital Progressive Wide Plasma Television

Model No. **TH-42PD50U**



**For assistance, please call : 1-888-VIEW-PTV (843-9788)**  
or visit us at [www.panasonic.com/contactinfo](http://www.panasonic.com/contactinfo) (U.S.A.)



**For assistance, please call : 787-750-4300**  
or visit us at [www.panasonic.com](http://www.panasonic.com) (Puerto Rico)

**For assistance, please call : 1-800-561-5505**  
or visit us at [www.panasonic.ca](http://www.panasonic.ca) (Canada)

Before connecting, operating or adjusting this product, please read these instructions completely.  
Please keep this manual for future reference.

English

TQBC2006-1

	<b>CAUTION</b> <b>RISK OF ELECTRIC SHOCK</b> <b>DO NOT OPEN</b>	
<b>WARNING:</b> To reduce the risk of electric shock, do not remove cover or back. No user-serviceable parts inside. Refer servicing to qualified service personnel.		

 The lightning flash with arrow-head within a triangle is intended to tell the user that parts inside the product are a risk of electric shock to persons.

 The exclamation point within a triangle is intended to tell the user that important operating and servicing instructions are in the papers with the appliance.

**WARNING :** To reduce the risk of fire or electric shock, do not expose this apparatus to rain or moisture. Do not place liquid containers (flower vase, cups, cosmetics, etc.) above the set (including on shelves above, etc.).

**WARNING :**

- 1) To prevent electric shock, do not remove cover. No user serviceable parts inside. Refer servicing to qualified service personnel.
- 2) Do not remove the grounding pin on the power plug. This apparatus is equipped with a three pin grounding-type power plug. This plug will only fit a grounding-type power outlet. This is a safety feature. If you are unable to insert the plug into the outlet, contact an electrician. Do not defeat the purpose of the grounding plug.

**Note:**  
Do not allow a still picture to be displayed for an extended period, as this can cause a permanent afterimage to remain on the Plasma Television.  
Examples of still pictures include logos, video games, computer images, teletext and images displayed in 4:3 mode.

	Manufactured under license from Dolby Laboratories. “Dolby” and the double-D symbols are trademarks of Dolby Laboratories.
---	---

	HDMI, the HDMI logo and High-Definition Multimedia Interface are trademarks or registered trademarks of HDMI Licensing LLC.
---	---

**License description:** To view the license information for software used in this product, press the Menu button and select [Set up] → [About] → [License]. (See page 34)

# Important Safety Instructions

- 1) Read these instructions.
- 2) Keep these instructions.
- 3) Heed all warnings.
- 4) Follow all instructions.
- 5) Do not use this apparatus near water.
- 6) Clean only with dry cloth.
- 7) Do not block any ventilation openings. Install in accordance with the manufacturer's instructions.
- 8) Do not install near any heat sources such as radiators, heat registers, stoves, or other apparatus (including amplifiers) that produce heat.
- 9) Do not defeat the safety purpose of the polarized or grounding-type plug. A polarized plug has two blades with one wider than the other. A grounding type plug has two blades and a third grounding prong. The wide blade or the third prong are provided for your safety. If the provided plug does not fit into your outlet, consult an electrician for replacement of the obsolete outlet.
- 10) Protect the power cord from being walked on or pinched particularly at plugs, convenience receptacles, and the point where they exit from the apparatus.
- 11) Only use attachments / accessories specified by the manufacturer.
- 12) Use only with the cart, stand, tripod, bracket, or table specified by the manufacturer, or sold with the apparatus. When a cart is used, use caution when moving the cart / apparatus combination to avoid injury from tip-over.
- 13) Unplug this apparatus during lightning storms or when unused for long periods of time.
- 14) Refer all servicing to qualified service personnel. Servicing is required when the apparatus has been damaged in any way, such as power-supply cord or plug is damaged, liquid has been spilled or objects have fallen into the apparatus, the apparatus has been exposed to rain or moisture, does not operate normally, or has been dropped.
- 15) To prevent electric shock, ensure the grounding pin on the AC cord power plug is securely connected.



# Dear Panasonic Customer

Welcome to the Panasonic family of customers. We hope that you will have many years of enjoyment from your new Plasma TV.

To obtain maximum benefit from your set, please read these Instructions before making any adjustments, and retain them for future reference.

Retain your purchase receipt also, and record the model number and serial number of your set in the space provided on the back cover of these instructions.

Visit our Panasonic Web Site: [www.panasonic.com](http://www.panasonic.com)

<b>For assistance, please call : 1-888-VIEW-PTV (843-9788)</b> or visit us at <a href="http://www.panasonic.com/contactinfo">www.panasonic.com/contactinfo</a>	<b>(U.S.A.)</b>
<b>For assistance, please call : 787-750-4300</b> or visit us at <a href="http://www.panasonic.com">www.panasonic.com</a>	<b>(Puerto Rico)</b>
<b>For assistance, please call : 1-800-561-5505</b> or visit us at <a href="http://www.panasonic.ca">www.panasonic.ca</a>	<b>(Canada)</b>

## Table of Contents

<b>Important Safety Instructions</b> .....	<b>3</b>	<b>First time setup</b> .....	<b>18</b>
<b>FCC STATEMENT</b> .....	<b>5</b>	<b>Watching TV programs</b> .....	<b>20</b>
<b>Safety Precautions</b> .....	<b>6</b>	VHF and UHF .....	20
Cleaning and maintenance .....	7	Cable TV .....	20
<b>Installation</b> .....	<b>8</b>	<b>Aspect Controls</b> .....	<b>21</b>
Receiver Location .....	8	<b>On-Screen Menu Displays for Navigation</b> .....	<b>22</b>
Optional External Equipment .....	8	<b>Sub-Menu Navigation</b> .....	<b>24</b>
Remote Control Battery Installation .....	8	Picture .....	24
<b>Accessories</b> .....	<b>9</b>	Audio .....	26
<b>Cable Connection</b> .....	<b>10</b>	Timer .....	28
Antenna Connection .....	11	Set up .....	29
Cable Box Connection .....	11	Lock .....	35
HDMI Connection .....	12	<b>Operating peripheral equipment</b> .....	<b>39</b>
Digital TV - Set-Top Box (DTV-STB) or		Programming the remote control code .....	39
DVD Connection .....	13	Infrared Code Index .....	40
Video Input Connection .....	13	Mode Operational Key Chart .....	43
Amplifier Connection (TO AUDIO AMP) .....	14	<b>Specifications</b> .....	<b>45</b>
Program Out Connection (PROG OUT) .....	14	<b>VIDEO/COMPONENT/HDMI input signals</b> .....	<b>45</b>
<b>Power ON / OFF</b> .....	<b>15</b>	<b>Troubleshooting Chart</b> .....	<b>46</b>
The Main Unit .....	15	<b>CUSTOMER SERVICES DIRECTORY (for U.S.A.)</b> ...	<b>47</b>
<b>Location of Controls</b> .....	<b>16</b>		
The Illuminated Remote Control .....	16		

# FCC STATEMENT

## FCC STATEMENT

This equipment has been tested and found to comply with the limits for an Other Class B digital device, pursuant to Part 15 of the FCC Rules. These limits are designed to provide reasonable protection against harmful interference in a residential installation. This equipment generates, uses and can radiate radio frequency energy and, if not installed and used in accordance with the instructions, may cause harmful interference to radio communications. However, there is no guarantee that interference will not occur in a particular installation. If this equipment does cause harmful interference to radio or television reception, which can be determined by turning the equipment off and on, the user is encouraged to try to correct the interference by one of the following measures:

- Reorient or relocate the receiving antenna.
- Increase the separation between the equipment and receiver.
- Connect the equipment into an outlet on a circuit different from that to which the receiver is connected.
- Consult the Panasonic Service Center or an experienced radio/TV technician for help.

### **FCC Caution:**

**To assure continued compliance, use only shielded interface cables when connecting TV to peripheral devices. Any changes or modifications not expressly approved by responsible party may cause harmful interference and could void the user's authority to operate this device.**

Responsible Party: Panasonic Corporation of North America  
One Panasonic Way, Secaucus, NJ 07094  
Contact Source: Panasonic Consumer Electronics Company  
1-888-VIEW-PTV (843-9788)  
email: consumerproducts@panasonic.com

### **CANADIAN NOTICE:**

For Models TH-42PD50U

This Class B digital apparatus complies with Canadian ICES-003.

# Safety Precautions

## WARNING

**KEEP UNNEEDED SMALL PARTS AND OTHER OBJECTS OUT OF THE REACH OF SMALL CHILDREN. THESE OBJECTS CAN BE ACCIDENTALLY SWALLOWED. ALSO, BE CAREFUL ABOUT PACKAGING MATERIALS AND PLASTIC SHEETS.**

### Set up

**Do not place the Plasma TV on sloped or unstable surfaces.**

- The Plasma TV may fall off or tip over.

**Do not place any objects on top of the Plasma TV.**

- If water spills onto the Plasma TV or foreign objects get inside it, a short-circuit may occur which could result in fire or electric shock. If any foreign objects get inside the Plasma TV, please consult an Authorized Service Center.

**Do not cover the ventilation holes.**

- Doing so may cause the Plasma TV to overheat, which can cause fire or damage to the Plasma TV.

**If using the pedestal, leave a space of 3 <sup>15</sup>/<sub>16</sub>" (10 cm) or more at the top, left and right, 2 <sup>3</sup>/<sub>8</sub>" (6 cm) or more at the bottom, and 2 <sup>3</sup>/<sub>4</sub>" (7 cm) or more at the rear. If using some other setting-up method, leave a space of 3 <sup>15</sup>/<sub>16</sub>" (10 cm) or more at the top, bottom, left and right, and <sup>3</sup>/<sub>4</sub>" (1.9 cm) or more at the rear.**

**Avoid installing this product near electronic equipment that is readily affected by electromagnetic waves.**

- It may cause interference in image, sound, etc. In particular, keep video equipment away from this product.

### AC Power Supply Cord

**The Plasma TV is designed to operate on 120 V AC, 50/60 Hz.**

**Securely insert the power cord plug as far as it will go.**

- If the plug is not fully inserted, heat may be generated which could cause fire. If the plug is damaged or the wall socket plate is loose, they should not be used.

**Do not handle the power cord plug with wet hands.**

- Doing so may cause electric shocks.

**Do not do anything that might damage the power cable. When disconnecting the power cable, hold the plug, not the cable.**

- Do not make any modifications to, place heavy objects on, place near hot objects, heat, bend, twist or forcefully pull the power cable. Doing so may cause damage to the power cable which can cause fire or electric shock. If damage to the cable is suspected, have it repaired at an Authorized Service Center.

**If the Plasma TV will not be used for a long period of time, unplug the power cord from the wall outlet.**

### If problems occur during use

**If a problem occurs (such as no picture or no sound), or if smoke or an abnormal odor is detected from the Plasma TV, unplug the power cord immediately.**

- Continued use of the TV under these conditions might cause fire or permanent damage to the unit. Have the TV evaluated at an Authorized Service Center. Service to the TV by any unauthorized personnel is strongly discouraged due to its high voltage dangerous nature.

**If water or foreign objects get inside the Plasma TV, if the Plasma TV is dropped, or if the cabinet becomes damaged, disconnect the power cord plug immediately.**

- A short may occur, which could cause fire. Contact an Authorized Service Center for any repairs that need to be made.

## CAUTION

**This Plasma TV is for use only with the following optional accessories. Use with any other type of optional accessories may cause instability which could result in the possibility of injury.**

(All of the following accessories are manufactured by Matsushita Electric Industrial Co., Ltd.)

- Pedestal (included) ..... TY-ST42PX5W
- Wall-hanging bracket (Vertical) ..... TY-WK42PV2W
- Wall-hanging bracket (Vertical) ..... TY-WK42PV3U
- Wall-hanging bracket (Angled) ..... TY-WK42PR2U

Always be sure to ask a qualified technician to carry out set-up.

### When using the Plasma TV

**Do not bring your hands, face or objects close to the ventilation holes of the Plasma TV.**

- Top of the Plasma TV is usually very hot due to the high temperature of exhaust air being released through the ventilation holes. Burns or personal injuries can happen if any body parts are brought too close. Placing any object near the top of the TV could also result in heat damage to the object as well as to the TV if its ventilation holes are blocked.

**Be sure to disconnect all cables before moving the Plasma TV.**

- Moving the TV with its cables attached might damage the cables which, in turn, can cause fire or electric shock.

**Disconnect the power plug from the wall outlet as a safety precaution before carrying out any cleaning.**

- Electric shocks can result if this is not done.

**Clean the power cable regularly to prevent it from becoming dusty.**

- Built-up dust on the power cord plug can increase humidity which might damage the insulation and cause fire. Unplug the cord from the wall outlet and clean it with a dry cloth.

**This Plasma TV radiates infrared rays; therefore, it may affect other infrared communication equipment.**

**Install your infrared sensor in a place away from direct or reflected light from your Plasma TV.**

---

## Cleaning and maintenance

---

**The front of the display panel has been specially treated. Wipe the panel surface gently using only a cleaning cloth or a soft, lint-free cloth.**

- If the surface is particularly dirty, soak a soft, lint-free cloth in a weak detergent solution and then wring the cloth to remove excess liquid. Use this cloth to wipe the surface of the display panel, then wipe it evenly with a dry cloth, of the same type, until the surface is dry.
- Do not scratch or hit the surface of the panel with fingernails or other hard objects. Furthermore, avoid contact with volatile substances such as insect sprays, solvents and thinner; otherwise, the quality of the surface may be adversely affected.

**If the cabinet becomes dirty, wipe it with a soft, dry cloth.**

- If the cabinet is particularly dirty, soak the cloth in a weak detergent solution and then wring the cloth dry. Use this cloth to wipe the cabinet, and then wipe it dry with a dry cloth.
- Do not allow any detergent to come into direct contact with the surface of the Plasma TV. If water droplets get inside the unit, operating problems may result.
- Avoid contact with volatile substances such as insect sprays, solvents and thinner; otherwise, the quality of the cabinet surface may be adversely affected or the coating may peel off. Furthermore, do not leave it for long periods in contact with articles made from rubber or PVC.

**Note:**

Do not allow a still picture to be displayed for an extended period, as this can cause a permanent after-image to remain on the Plasma TV.

Examples of still pictures include logos, video games, computer images, teletext and images displayed in 4:3 mode.

# Installation

## Receiver Location

This unit is intended to be used with the stand or bracket. Consult your dealer for available options. Position for comfortable viewing. Avoid placing where sunlight or other bright light (including reflections) will fall on the screen. Use of some types of fluorescent lighting can reduce remote control transmitter range.

Adequate ventilation is essential to prevent internal component failure. Keep away from areas of excessive heat or moisture.

## Optional External Equipment

The Video/Audio connection between components can be made with shielded video and audio cables. For best performance, video cables should utilize 75 ohm coaxial shielded wire. Cables are available from your dealer or electronic supply store.

Before you purchase any cables, be sure you know what type of output and input connectors your various components require. Also determine the length of cable you will need.

## Remote Control Battery Installation

1. Open the cover.

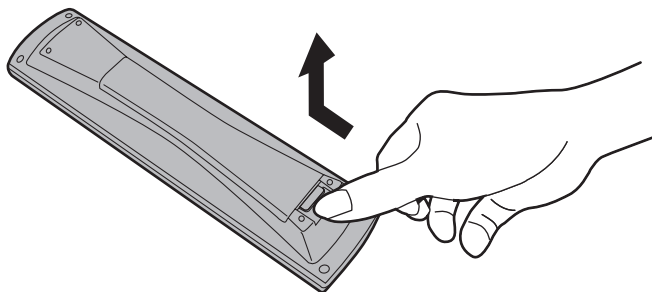

2. Install the batteries and replace the cover. Note the correct polarity (+ and -).

Two AA size

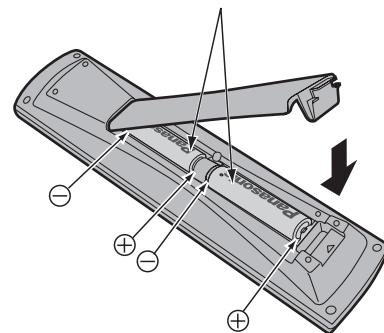

### Helpful Hints:

For frequent remote control users, replace old batteries with alkaline batteries for longer life.

### Helpful Hints:

Whenever you remove the batteries, **you may need to reset the remote control infrared codes**. We recommend that you record the code on page 40, prior to setting up the remote control.

### ⚠️ **Precaution on battery use**

Incorrect installation can cause battery leakage and corrosion that will damage the remote control transmitter.

#### **Observe the following precautions:**

1. Batteries should always be replaced as a pair. Always use new batteries when replacing the old set.
2. Do not combine a used battery with a new one.
3. Do not mix battery types (example: "Zinc Carbon" with "Alkaline").
4. Do not attempt to charge, short-circuit, disassemble, heat or burn used batteries.
5. Battery replacement is necessary when remote control acts sporadically or stops operating the TV set.



# Accessories

Check that you have the Accessories and items shown



Operating Instruction

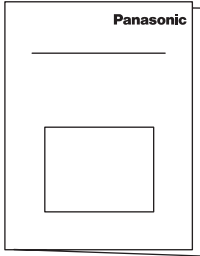

Remote control  
EUR7627Z60



Batteries for the remote control  
(AA Battery × 2)



Warranty card  
(for U.S.A.)  
(for Canada)

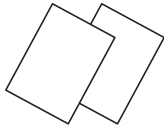

Product Registration Card  
(for U.S.A.)  
Customer Care Plan Card  
(for U.S.A.)

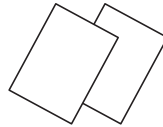

Pedestal  
TY-ST42PX5W

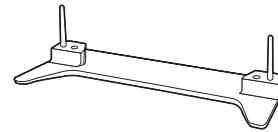

AC cord

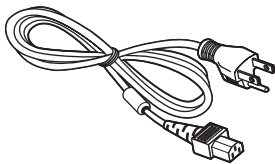

Cable clamber × 2

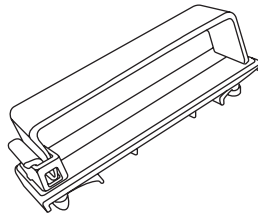

F-Type antenna adapter  
(for 5C-2V) ( × 1)

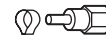

## Optional Accessories

- Wall-hanging bracket (vertical)  
TY-WK42PV2W  
TY-WK42PV3U

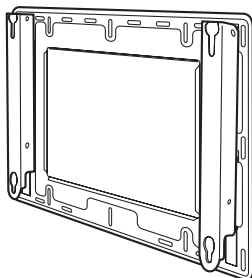

- Wall-hanging bracket (Angled)  
TY-WK42PR2U

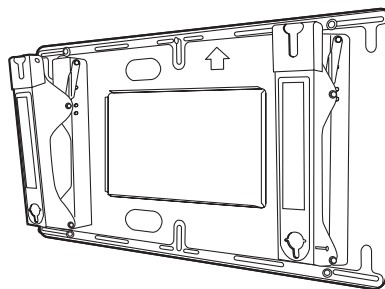

# Cable Connection

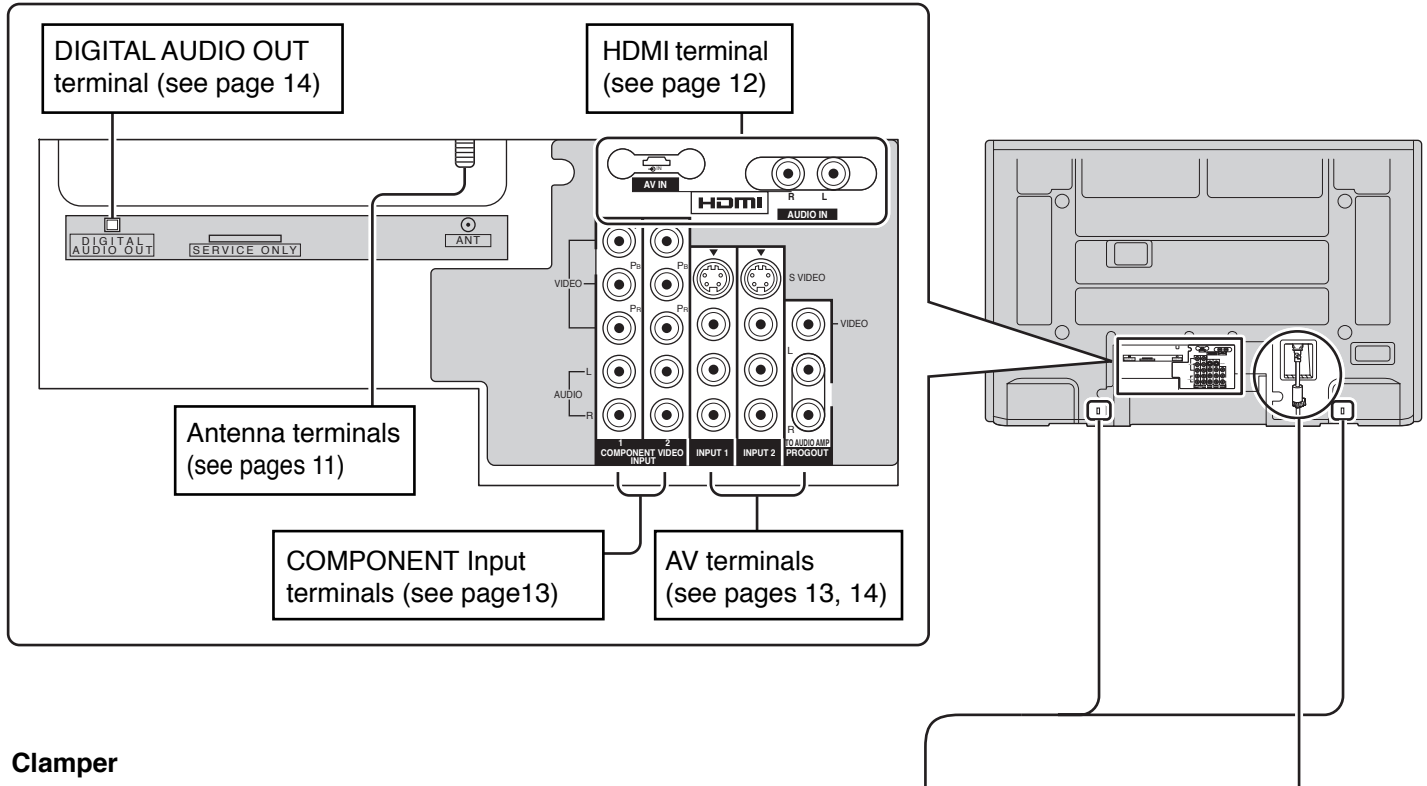

## Clamper

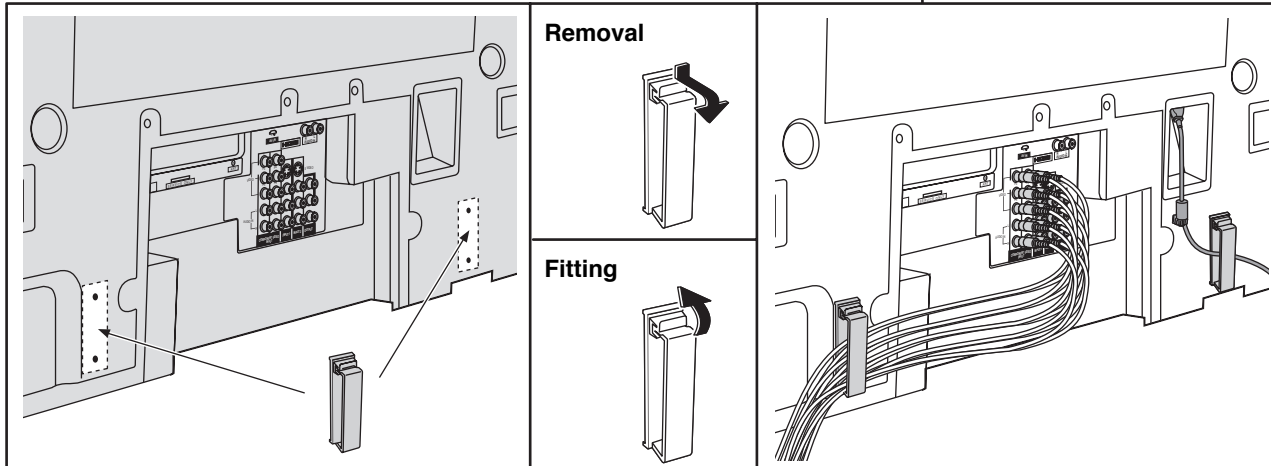

## - AC cord fixing

- ① Connect power plug to the socket of the main body.
- ② Fix the clamper.

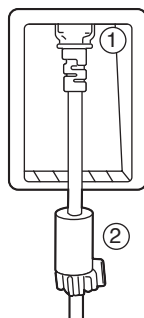

How to fix:  
Fix by pushing in until a clicking sound is heard.

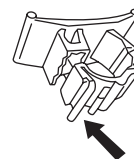

How to release:  
Pull up while drawing in the knob.

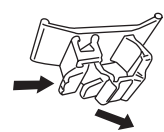

**Note:** To avoid noise do not put the Antenna cable and AC cord together.

**Note:**

Cables and connectors are not supplied with this set.

## Antenna Connection

The RF input mode must be set to Antenna (see pages 19, 30).

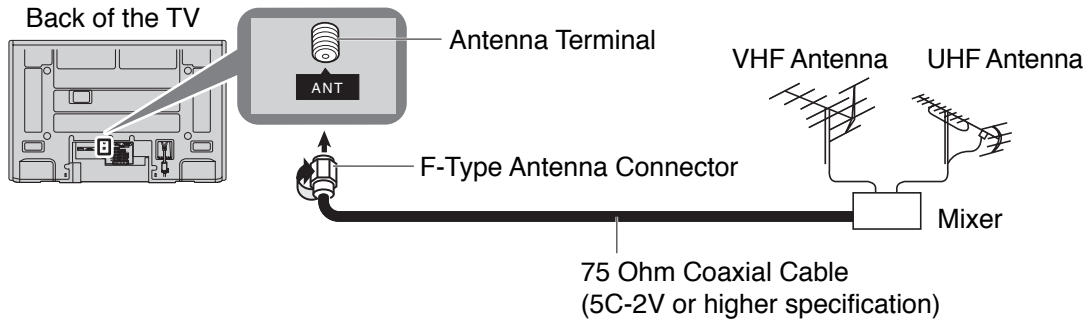

## Cable Box Connection

- For reception of cable channels (01 - 135), connect the cable supplied by your local cable company. The RF input mode must be set to Cable (see pages 19, 30).
- Certain cable systems offset some channels to reduce interference or view Premium (scrambled) channels. A cable converter box is required for proper reception. Check with your local cable company for its compatibility requirements.
- Set the TV channel to CH3 or CH4 when using this connection.

### Cable Box

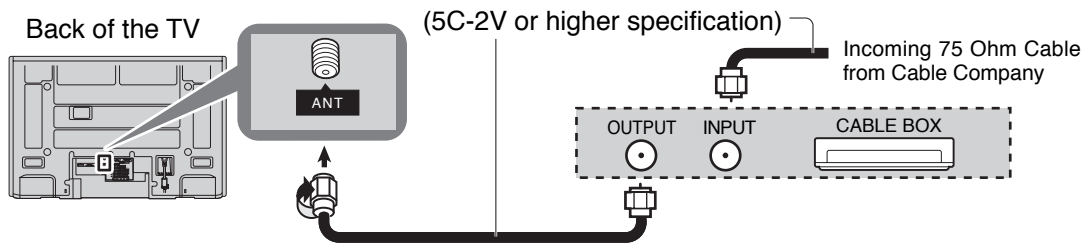

### Cable Box and VCR

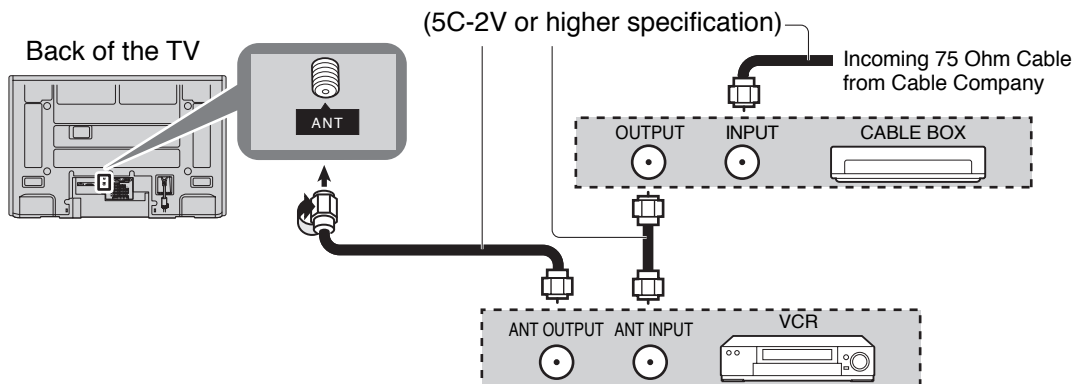

## HDMI Connection

HDMI\*<sup>1</sup> (High Definition Multi media Interface) is the first all digital consumer electronics A/V interface that supports uncompressed standard. The HDMI terminal supports both video and audio information.

To the HDMI\*<sup>1</sup> input terminal, you can connect an EIA/CEA-861/861B\*<sup>2</sup> compliant consumer electronic device, such as a Set-Top Box or DVD player with HDMI or DVI output terminal.

Input a High-bandwidth Digital Content Protection (HDCP) high-definition picture source to this HDMI terminal, so you can display high-definition pictures on this TV in digital form.

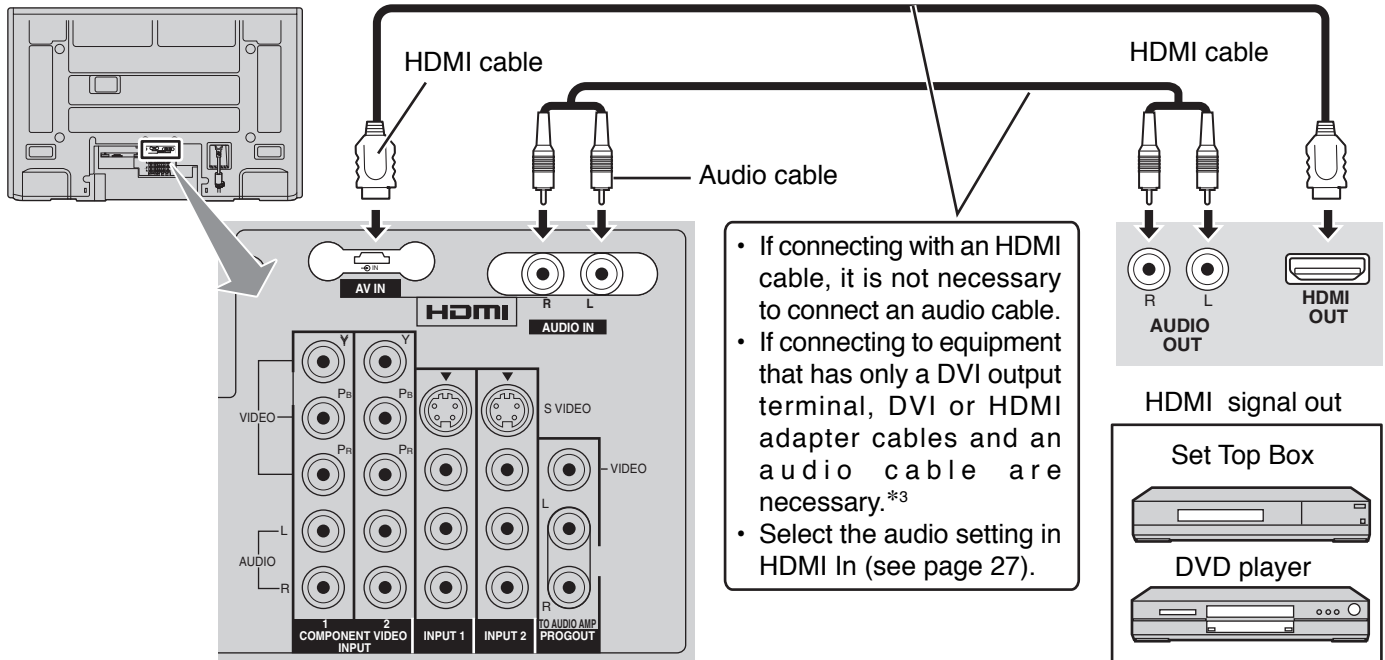

### Compatible VIDEO Signal

	No. of dots (H × V)	Vertical scanning frequency (Hz)
<b>1080i</b>	1,920 × 1,080i	59.94/60
<b>720p</b>	1280 × 720p	59.94/60
<b>480p</b>	720 × 480p, 640 × 480p	59.94/60, 59.94/60
<b>480i</b>	720(1,440) × 480i	59.94/60

#### Notes:

- This input terminal is not intended for use with computers.
- 1080i and 720p signals will be re-formatted for viewing on your plasma display.

### Compatible sampling frequency of AUDIO signal through HDMI (L.PCM) : 48 kHz / 44.1 kHz / 32 kHz

#### Notes:

- This HDMI connector is Type A.
- If you connect equipment without a digital output terminal, connect to the COMPONENT VIDEO, S VIDEO or VIDEO input terminal on the TV so you can enjoy an analog signal.
- If you cannot display the picture because your Digital Set-Top Box does not have a DIGITAL OUT terminal Output setting, use the component Video Input (or the S Video Input or Video Input). In this case the picture will be displayed as an analog signal.

\*1. HDMI, the HDMI logo and High-Definition Multimedia Interface are trademarks or registered trademarks of HDMI Licensing LLC.  
 \*2. EIA/CEA-861/861B profiles compliance covers profiles for transmission of uncompressed digital video including high bandwidth digital content protection.  
 \*3. HDMI-DVI conversion cable (TY-SCH03DH): available from Panasonic Website (USA only). Consult your consumer electronics dealer for availability details.

## Digital TV - Set-Top Box (DTV-STB) or DVD Connection

This TV is capable of displaying 1080i, 720p, 480p and 480i DTV signals when connected to a DTV Tuner Set-Top Box (STB). This TV also utilizes a progressive scan doubler, which de-interlaces the NTSC signal and progressively scans the image.

- To view DTV programs, connect the STB to the component video input terminals (Y, P<sub>B</sub>, P<sub>R</sub>) of the TV. Component color inputs provide luminance and separate color signal.
- Set the output of the STB to either 1080i, 720p, 480p or 480i.
- A DTV signal must be available in your area.
- Use a Panasonic DTV-STB (Digital TV-Set-Top Box) or DVD Player.

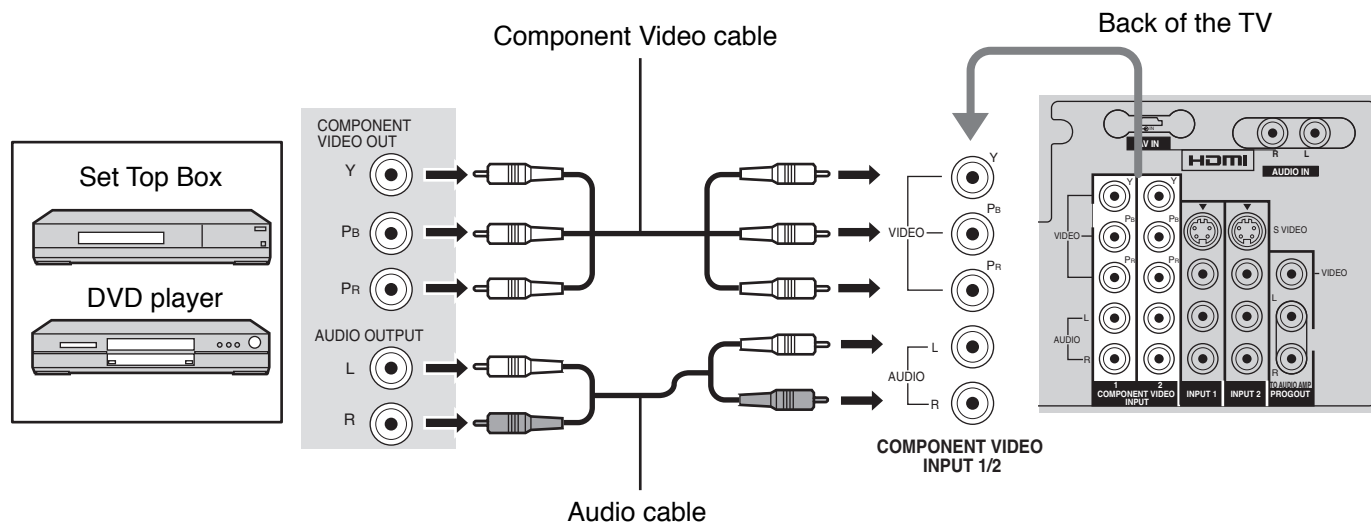

**Note:**

720p signals will be converted to 1080i format and output to the display.

## Video Input Connection

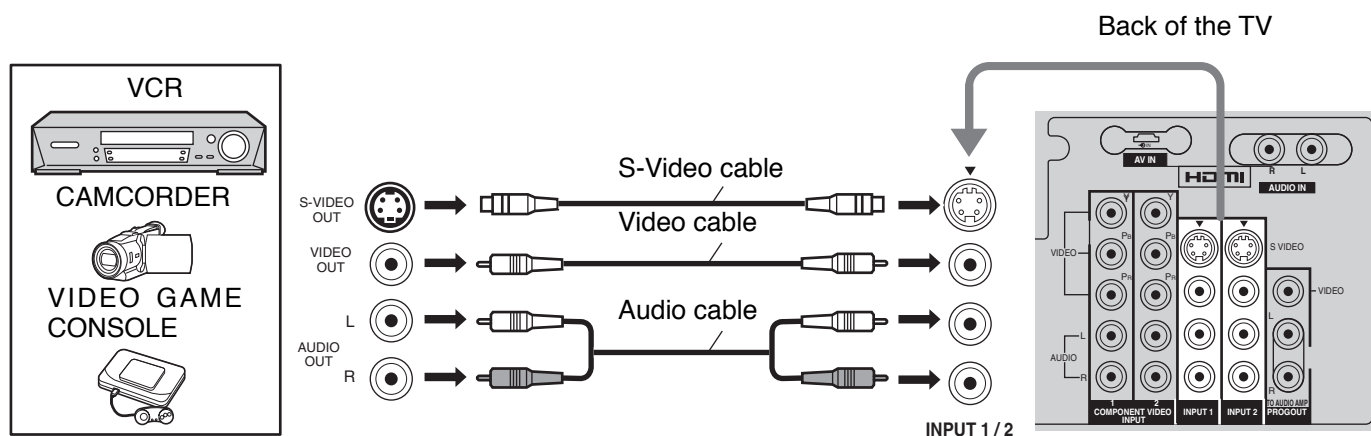

**Note:**

The S Video input will override the composite video signal when S Video cable is connected. Connect either S Video cable or Video cable.

## Amplifier Connection (TO AUDIO AMP)

For a full Home Theater sound experience, an external Dolby Digital<sup>®</sup> decoder and a multichannel amplifier must be connected to the DIGITAL AUDIO OUT terminal on the TV.

\* Dolby Digital 5.1 channel surround sound delivers digital-quality sound. Dolby Digital provides five discrete full-bandwidth channels for front left, front right, center, surround left and surround right, plus a LFE (Low Frequency Effect) subwoofer channel.

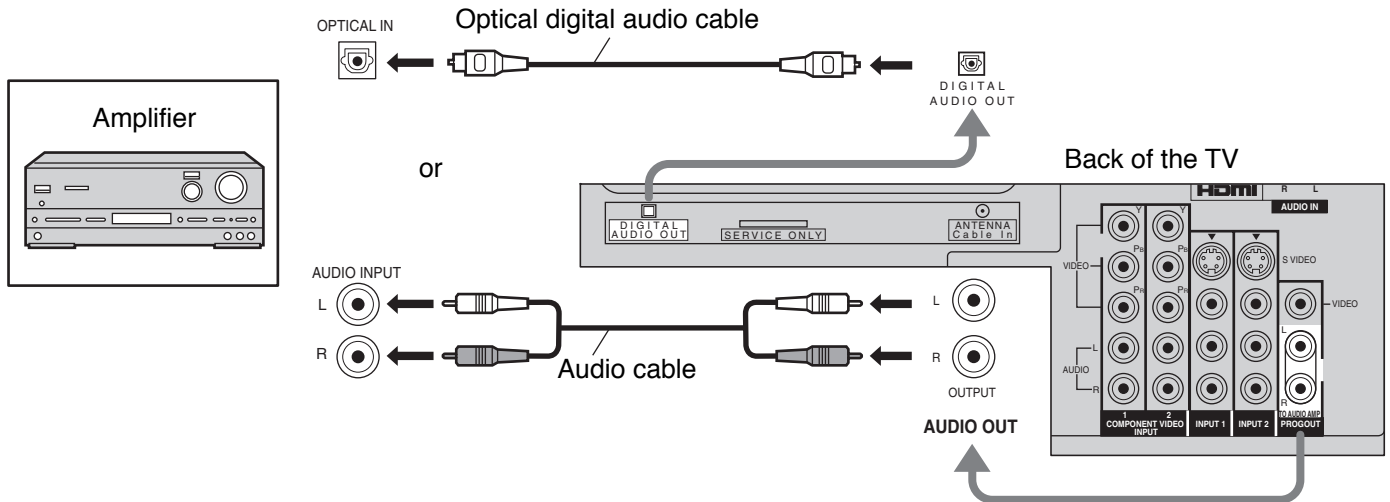

### Procedure

1. Select Speakers "Off" in Audio menu (see page 27).
2. Adjust the amplifier volume to the desired level.

### Notes:

- Depending on your DVD player and DVD-Audio software the copyright protection function may operate and disable optical output.
- External speakers cannot be connected directly to OUTPUT terminals.
- When ATSC channel is selected, the output from the DIGITAL AUDIO OUT jack will be Dolby Digital. When NTSC channel is selected, the output will be PCM.

## Program Out Connection (PROG OUT)

See optional equipment manual for further instructions for recording and monitoring.

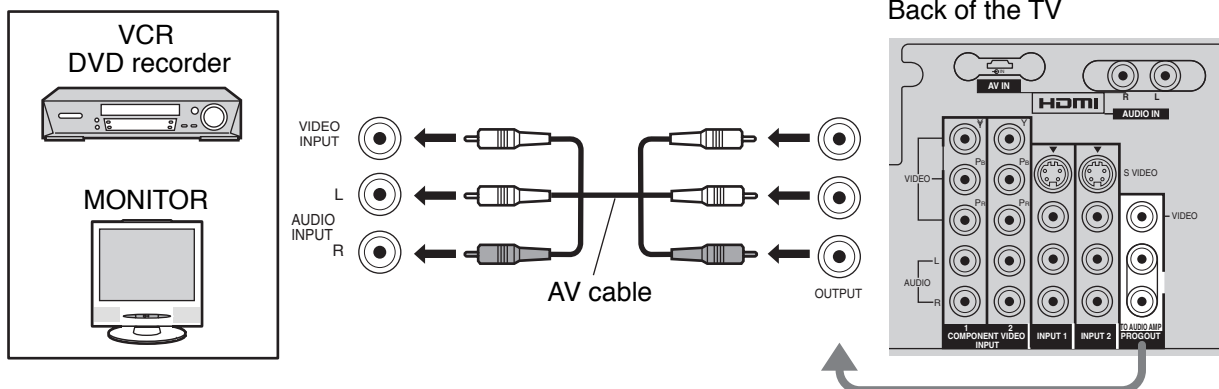

### Notes:

- When a device (STB, DVD, etc.) is connected to the HDMI terminal (see page 12), only audio signals will be output. No video signals will be output.
- When receiving digital channel signals, all digital formats are down-converted to composite NTSC video to be output through Program Out terminals.
- Some programs contain Macrovision signal to prevent VCR recording.

# Power ON / OFF

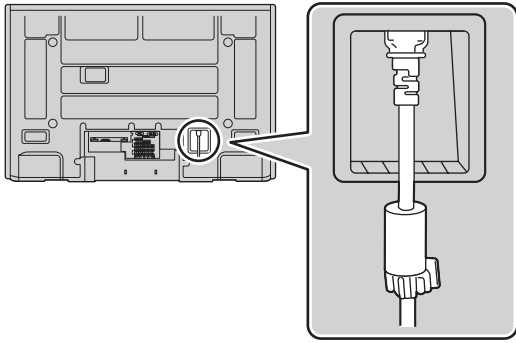

- 1 Connect the AC cord plug to the Plasma TV.
  - Fix the power cord plug securely with the clammer (see page 10).

- 2 Connect the plug to the wall outlet.

**Power indicator** Power on : Red  
Power off : No Light

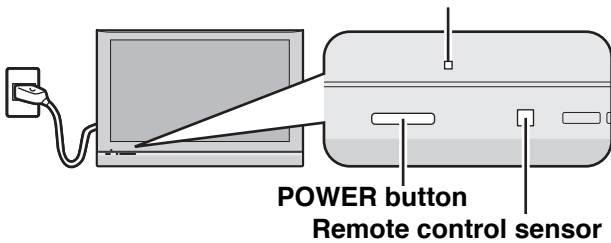

- 3 Press POWER button on front of this unit. First time setup is displayed on screen.

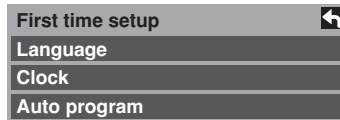

(Refer to P18-19 for operation)

- 4  Press to turn the TV on or off.

## Notes:

- The TV will still consume some power as long as the power cord is inserted into the wall outlet.
- The First time setup screen is displayed only the first time you turn the power on after purchase. If you wish to change the settings of these items later, select them via the Setup menu.

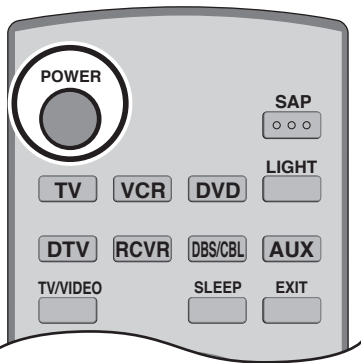

## The Main Unit

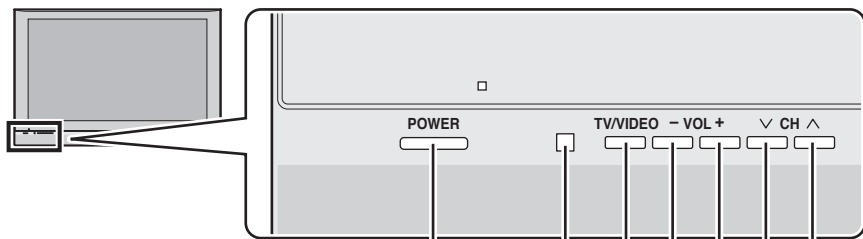

**POWER button**  
Press to turn the TV's main power on/off.

**TV/VIDEO**  
Change the input mode.

**Remote control sensor**  
Within about 23 feet (7 meters) in front of the TV set.

# Location of Controls

## The Illuminated Remote Control

### POWER

Turn the TV ON or OFF.

#### Mode Selection buttons (see page 39)

**TV:** TV  
**VCR:** VCR  
**DVD:** DVD  
**DTV:** Digital TV  
**RCVR:** Receiver/Amplifier  
**CBL:** Cable TV  
**AUX:** Aux

### TV/VIDEO

Change the input mode.

- Press to display the Input selection menu.

Input select
[1] TV
[2] Component 1
[3] Component 2
[4] HDMI
[5] Video 1
[6] Video 2

- Press corresponding number key on the remote control to select the input of your choice.

#### Note:

Video input can also be selected by pressing <sup>TV/VIDEO</sup> , then the CH ▲▼ buttons, and push "OK" key.

### R-TUNE

Switch to previously viewed channel and input modes.

Operation of other Device  
(see pages 43, 44)





## SAP

- Digital channel  
Select the audio track (if available).

Audio Track 1 of 1  
(English)

- Analog channel  
Cycle through different audio modes.

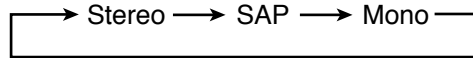

## LIGHT

Illuminate the remote control buttons. The selected button blinks when lit.

**SLEEP timer** (minutes)



**EXIT menus** Normal viewing, from each menu.

## MUTE

Mute the sound. Press again to cancel the mute.

## ASPECT

Change the screen aspect (see page 21).

## RECALL

Display or remove the channel banner.

Channel, Program  
and Station identifier

Program end time

Program title

Clock

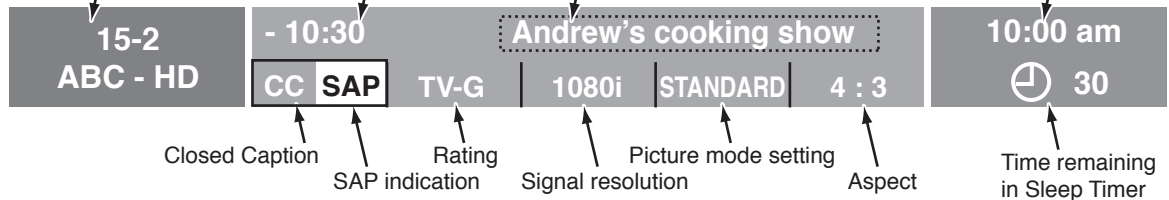

▲ **CH**: Change to the next channel up.

▲ : Move cursor upward during menu mode.

◀ **VOL** : Reduces volume.

◀ : Move cursor to the left during menu mode.

Choose menu and submenu entry.

**VOL ▶**: Increase volume.

▶ : Move cursor to the right during menu mode.

## MENU

Display Main Menu

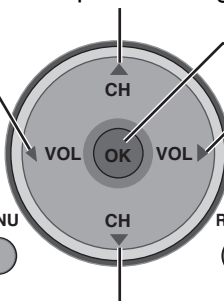

## RETURN

Press to return to previous Menu.

▼ **CH**: Change to the next channel down.

▼ : Move cursor downward during menu mode.

## Direct program number selection buttons

**PROG --**: When tuning digital channel, press the button to enter the minor number in a compound channel number.

- To enter the channel number  
ex. CH 15-1: [1] → [5] → [-] → [1] → [OK]

# First time setup

For your convenience, First time setup menu will be displayed on screen when the set is turned on for the first time. If needed, follow the menus and procedures displayed on-screen for setting up the features. You can also make the settings in Setup menu (see pages 29, 30).



## Language

Allows you to select the language used for On Screen Displays.

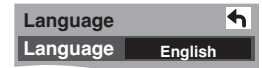
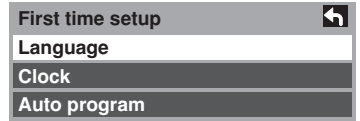
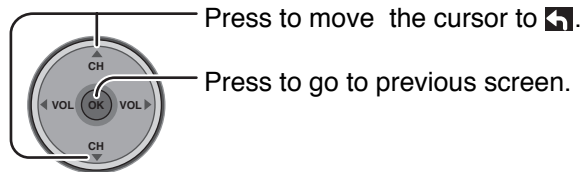
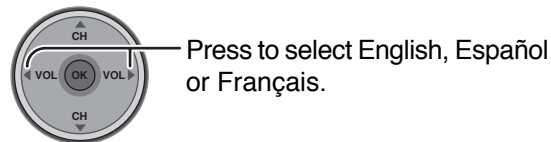
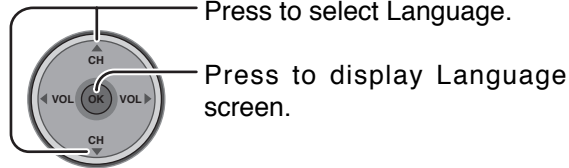

## Clock

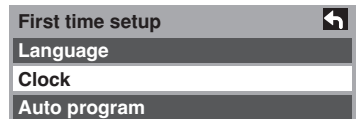
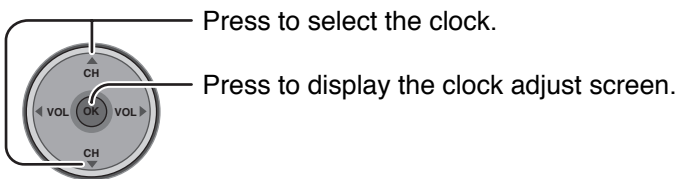

### Mode

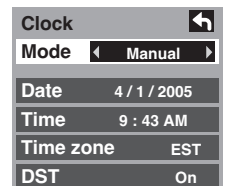
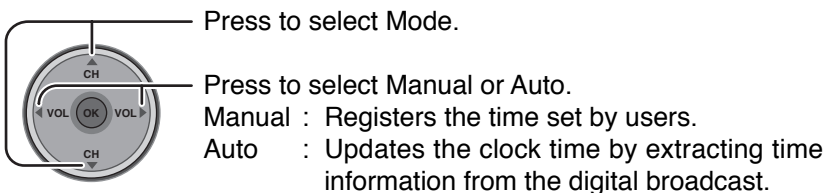

### Date

Valid when Mode is set to manual.

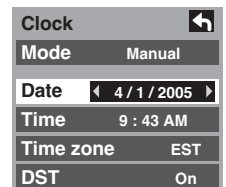
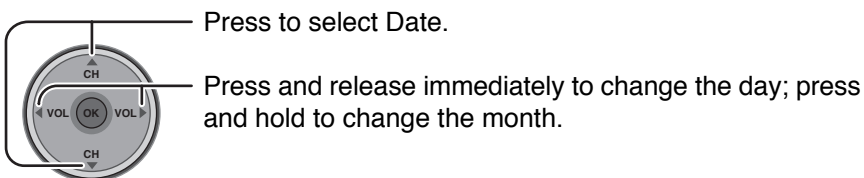

## Time

Valid when Mode is set to manual.

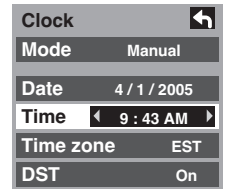
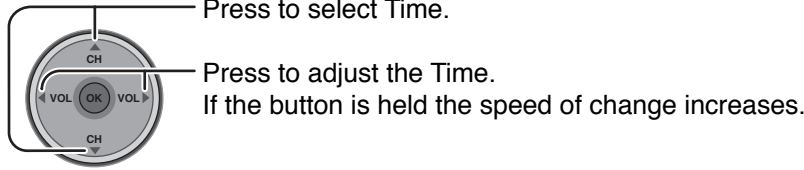

## Time zone

Valid when Mode is set to Auto.

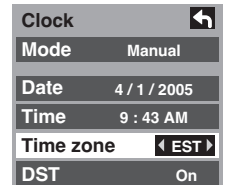
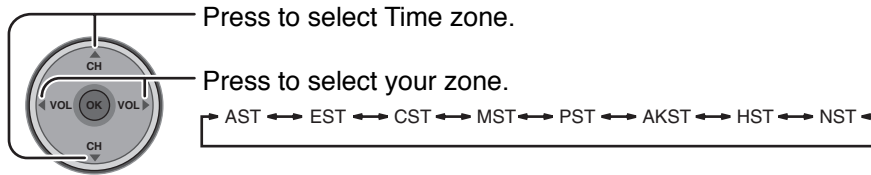

## Daylight saving

Valid when Mode is set to Auto.

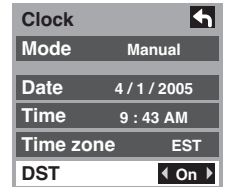
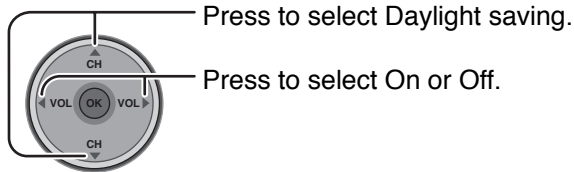

## Auto program

You can scan All (Analog and Digital) channels. If needed, follow the menus and procedures displayed on-screen for setting up the features.  
You can also make the settings in Setup menu.

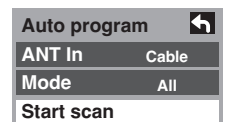
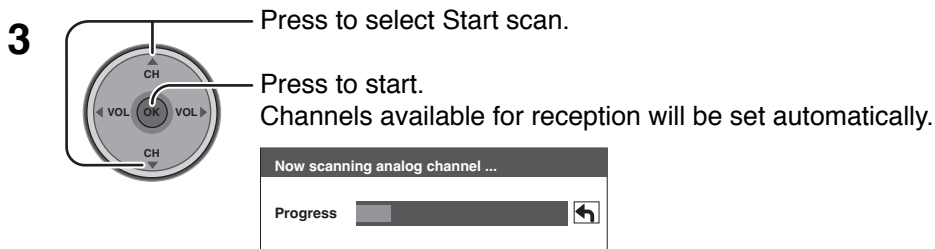
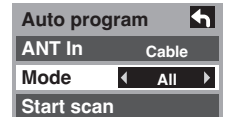
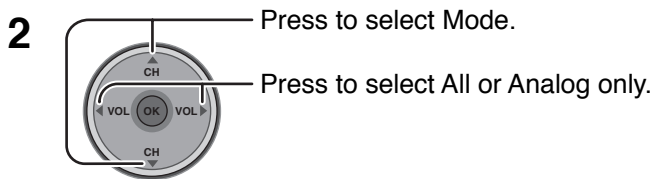
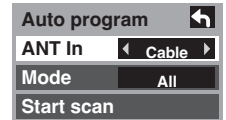
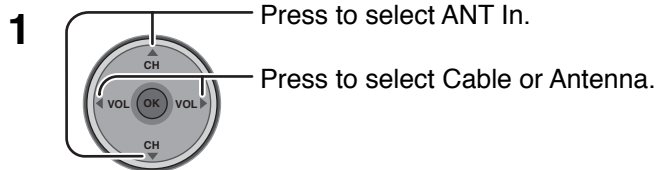





## To exit the menu screen

Press EXIT

# Watching TV programs

## VHF and UHF

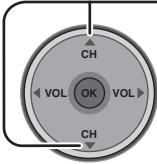



-  Press to operate the TV set with the remote control.
-  Press to turn the TV on.
-  Press to select desired channel.
  - You can also use the direct program number selection buttons and PROG-button (see page 17).
-  Select the desired volume level.

### Notes:

- The channel number and volume level remain the same even after the TV is turned off.
- Power consumption and howling sound can be reduced if the volume level is lowered.

## Cable TV

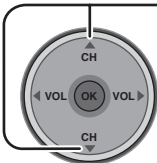
Make sure that registration with cable TV provider and connection of equipment are completed.

-  Select TV channel 3 or 4.
-  Press to operate the cable box with the remote control.
-  Press to turn the cable box on.
  - Point the remote control towards the cable box.**Notes:**
  - The remote control code number is set for Panasonic products.
  - To operate other manufacturer's product (see pages 39 - 42).

# Aspect Controls

Lets you choose the aspect depending on the format of the received signal and your preference.



**ASPECT** Press to change the aspect mode.

**Note:**

The available aspect modes depend on the receiving signal.

- 480i : 4:3, Full, Just or Zoom
- 480p (4:3) : 4:3, Full, Just or Zoom
- 480p (16:9) : 4:3, Full, Just or Zoom
- 1080i / 720p : 16:9 only

Mode	Picture	Explanation
4 : 3		Displays a 4:3 picture at its standard 4:3 size with gray side bars. (It may create an after-image on screen if displayed for a prolonged period of time.)
Zoom		Expands a 4:3 picture uniformly (width and height) to full screen width and then repositions the picture vertically. (Recommended for letterbox. This will show picture at full screen size.)
Full		Displays a picture at full screen size. (Recommended for anamorphic pictures.)
Just		Stretches the right and left edges of a 4:3 picture to fill the screen, and the center of the screen has aspect correction applied. The size of the picture depends on the original signal. (Recommended for regular TV viewing.)

# On-Screen Menu Displays for Navigation

## Picture adjust (See page 24)

Press to select picture menu.

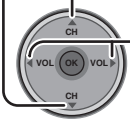

Press to select or adjust picture items.

Picture 1/2		Picture 2/2	
Normal	No	Color Temp	Cool
Pic. Mode	Standard	Color Mng.	Off
Picture	+30	Zoom adjust	
Brightness	0	Other adjust	
Color	0		
Tint	0		
Sharpness	+10		

Press to select Other adjust.

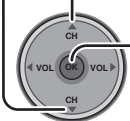

Press to display Other adjust menu.

Other adjust	
Video NR	Off
3D Y/C Filter	Off
Color Matrix	SD
MPEG NR	Off
Black level	Dark

## Audio adjust (See page 26)

Press to select Audio menu.

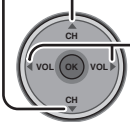

Press to adjust Audio items.

Audio	
Normal	Set
Bass	+7
Treble	+7
Balance	0
Other adjust	

Press to select Other adjust.

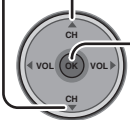

Press to display Other adjust menu.

Other adjust	
AI Sound	On
Surround	Off
Speakers	On
HDMI In	Auto
Audio leveler	0

## Timer adjust (See page 28)

Press to select either Sleep or Timer 1 - 5.

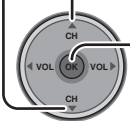

Press to display desired Timer Adjust menu.

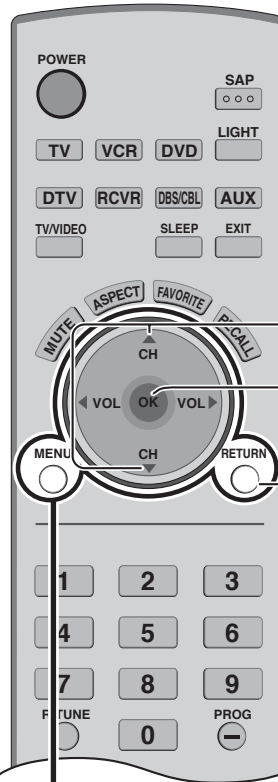

Press to select.

Press to enter each adjust screen.

Press to return to previous menu.

MENU  
Press button to display main menu.

	Picture
	Audio
	Timer
	Lock
	Setup

Timer		Sleep	
Sleep	→	Sleep	60
Timer 1	→		
Timer 2	→		
Timer 3	→		
Timer 4	→		
Timer 5	→		
		Timer 1	
		CH	310 - 1
		Day	EVR FRI
		On time	10:00 AM
		Off time	11:00 AM
		Set	On

# On-Screen Menu Displays for Navigation

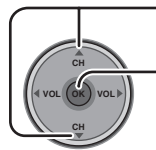
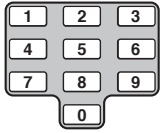

Press to select

Press to go to each setting screen.

Enter a 4-digit password.

## Lock settings (See page 35)

Enter password.

-----

- Lock
- Mode Off
- Channel
- Program
- Change password

## Channel lock

Channel lock

- CH 1 3 - 0
- CH 2
- CH 3
- CH 4
- CH 5
- CH 6
- CH 7

Program lock

- MPAA
- U.S.TV
- C.E.L.R.
- C.F.L.R.
- Monitor out On

## Change password

Enter new password.

-----

Enter new password, again.

-----

## Set up (See page 29)

Setup 1/2

- CH scan Fav.
- Language
- Clock
- Program channel
- Input labels
- CC

Setup 2/2

- Other adjust
- About
- Reset

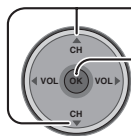

Press to select

Press to go to each adjust screen.



Press to return to previous screen.

## Language (See page 18)

Language

- Language English

## Program channel (See page 30)

Program channel

- Auto
- Manual
- Signal meter



## Clock adjust (See pages 18, 19)

Clock

- Mode Manual
- Date 4 / 1 / 2005
- Time 9 : 43 AM
- Time zone EST
- DST On

## CC (Closed Caption) (See page 32)

CC

- Mode Off
- Analog CC1
- Digital Primary
- Digital setting
- CC reset

## Input labels (See page 32)

Input labels

- Comp. 1
- Comp. 2
- HDMI
- Video 1
- Video 2

## Other Adjust (Setup) (See page 34)

Other Adjust

- Auto Power On Off
- Side Bar Off

## About (See page 34)

About

- Version
- License

## Auto program (See page 30)

Auto program

- ANT In Cable
- Mode All
- Start scan

## Manual program (See page 30)

CH	Caption	Favorite	Add
1	---	---	No
2	---	2	Yes
3	---	---	No
4	---	---	No
5	---	---	No
6	---	---	No
7	---	---	No
8	---	---	No
9	---	---	No
10	---	---	No

## Signal meter scene (See page 31)

Signal meter

- CH 2 - 1
- Signal strength
- Current 85 %
- Peak level 85 %

# Sub-Menu Navigation

## Picture

Press the MENU button to display the Main menu.

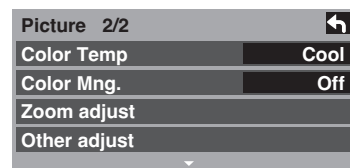
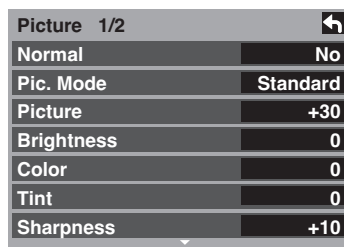
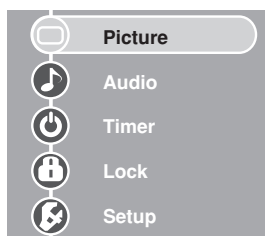
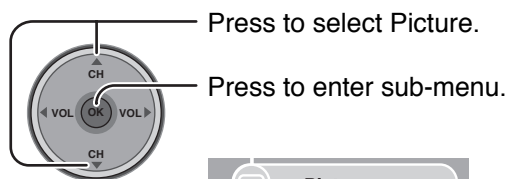

### Normal / Picture / Brightness / Color / Tint / Sharpness / Color Temp / Color Mng.

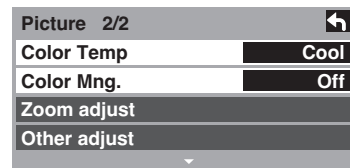
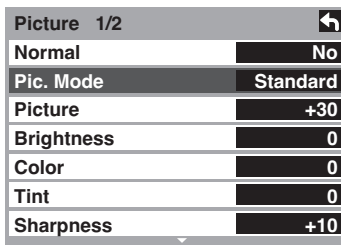
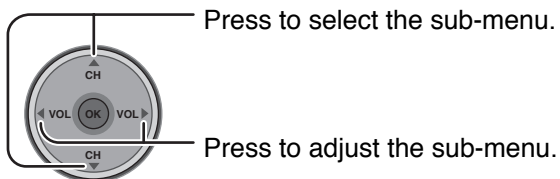

Item	Explanations
<b>Normal</b>	Resets all picture adjustments to factory default settings.
<b>Picture</b>	Adjusts white areas of picture.
<b>Brightness</b>	Adjusts dark areas of picture.
<b>Color</b>	Adjusts desired color intensity.
<b>Tint</b>	Adjusts natural fresh tones.
<b>Sharpness</b>	Adjusts clarity of outline detail.
<b>Color Temp (temperature)</b>	To increase or decrease Warm (red) and Cool (blue) colors to suit personal preferences.
<b>Color Mng. (color Management)</b>	Color Mng. On Enable vivid color adjustment automatically.

### Pic Mode

Choose the pre-set picture mode that best suits the program you are viewing. This feature also affects Color Temp setting.

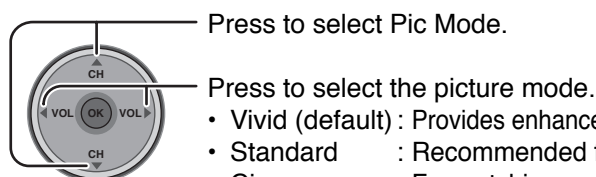

- Vivid (default) : Provides enhanced picture contrast and sharpness for viewing in a well-lit room.
- Standard : Recommended for normal viewing conditions with subdued room lighting.
- Cinema : For watching movies in a darkened room. It provides a soft, film-like picture.

**Note:** Each mode has its own picture settings (Color, Tint, Brightness, Picture and Sharpness).



## Zoom adjust

Adjust the Zoom position.  
It works when Aspect mode is Zoom.

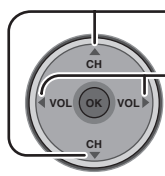

Press to select Zoom adjust menu.

Press to adjust Size / V-Position.

- Size : Adjust the vertical size.
- V-Position : Adjust the vertical position.

Picture 1/2	
Normal	No
Pic. Mode	Standard
Picture	+30
Brightness	0
Color	0
Tint	0
Sharpness	+10

Picture 2/2	
Color Temp	Cool
Color Mng.	Off
Zoom adjust	
Other adjust	

## Other adjust

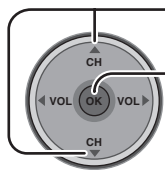

Press to select Other adjust.

Press to display the sub-menu.

Picture 1/2	
Normal	No
Pic. Mode	Standard
Picture	+30
Brightness	0
Color	0
Tint	0
Sharpness	+10

Picture 2/2	
Color Temp	Cool
Color Mng.	Off
Zoom adjust	
Other adjust	

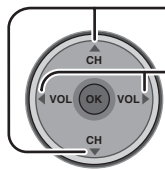

Press to select the sub-menu.

Press to select or adjust the sub-menu.

Other adjust	
Video NR	Off
3D Y/C Filter	Off
Color Matrix	SD
MPEG NR	Off
Black level	Dark

Item	Explanations
<b>Video NR</b>	Reduces noise, commonly called snow. Leave off when receiving a strong signal.
<b>3D Y/C Filter</b>	Minimizes noise and cross-color in the picture.
<b>Color Matrix</b>	Select SD or HD. <ul style="list-style-type: none"> <li>• SD : When the input signal is a normal TV system (NTSC).</li> <li>• HD : When the input signal is a High-Definition system (ATSC).</li> </ul> Displays 480p input signals in natural color from digital equipment adapters connected to COMPONENT VIDEO INPUT (Y, P <sub>B</sub> , P <sub>R</sub> ) terminals. Select HD or SD to adjust color parameters automatically for HD (high definition) or SD (standard definition). <b>Notes:</b> <ul style="list-style-type: none"> <li>• This feature is available only with 480p signal and not available with regular TV (NTSC) program.</li> <li>• When viewing a nonstandard DTV signal format, you can change color parameters manually for the best picture quality.</li> </ul>
<b>MPEG NR</b>	Unique noise to DVD, STB, etc. will be reduced.
<b>Black level</b>	Select Light or Dark [Light : VIDEO/YUV 480i, Dark : 480P(VGA)/1080i] Valid only for external input signals.

# Sub-Menu Navigation

## Audio

Press the MENU button to display the Main menu.

Press to select Audio.

Press to enter sub-menu.

Picture	
<b>Audio</b>	
Timer	
Lock	
Setup	

<b>Audio</b>		
Normal		Set
Bass		+ 7
Treble		+ 7
Balance		0
Other adjust		

### Normal / Bass / Treble / Balance

Press to select Normal, Bass, Treble or Balance.

Press to select or adjust the sub-menu.

<b>Audio</b>		
Normal		Set
Bass		+ 7
Treble		+ 7
Balance		0
Other adjust		

Item	Explanations
<b>Normal</b>	Reset Bass, Treble and Balance adjustments to factory default settings.
<b>Bass</b>	Increase or decrease the bass response.
<b>Treble</b>	Increase or decrease the treble response.
<b>Balance</b>	Emphasize the left / right speaker volume.

### Other adjust

**1**

Press to select Other adjust.

Press to display the sub-menu.

<b>Audio</b>		
Normal		Set
Bass		+ 7
Treble		+ 7
Balance		0
Other adjust		

**2**

Press to select the sub-menu.

Press to select or adjust the sub-menu.

<b>Other adjust</b>		
AI Sound		On
Surround		Off
Speakers		On
HDMI In		Auto
Audio leveler		0

#### ■ AI Sound

Equalize overall volume levels across all channels. AI sound is not available in VIDEO input mode (see page 22).

Press to select AI Sound.

Press to select On or Off.

<b>Other adjust</b>		
AI Sound		On
Surround		Off
Speakers		On
HDMI In		Auto
Audio leveler		0

**Note:** Fixed to Off when “Speakers” is set to Off.

## ■ Surround

Enhances audio response when listening to stereo.

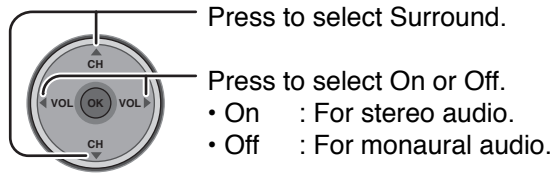

**Note:** Fixed to Off when “Speakers” is set to Off.

Other adjust	↩
AI Sound	On
Surround	Off
Speakers	On
HDMI In	Auto
Audio leveler	0

## ■ Speakers

This feature is used to turn TV speakers On or Off (see page 14, Amplifier Connection).

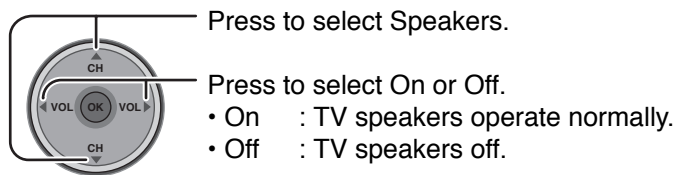

**Note:** AI Sound, Surround and Audio leveler are not available when selecting Off.

Other adjust	↩
AI Sound	On
Surround	Off
Speakers	On
HDMI In	Auto
Audio leveler	0

## ■ HDMI In

When using HDMI (see page 12), this feature will let you switch Analog or and Digital Input.

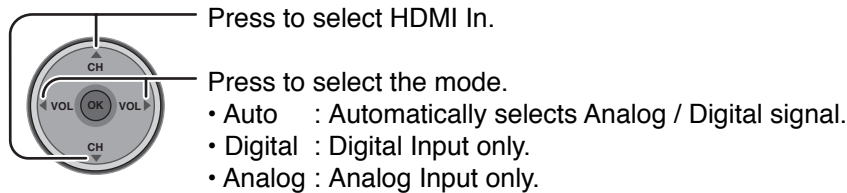

Other adjust	↩
AI Sound	On
Surround	Off
Speakers	On
HDMI In	Auto
Audio leveler	0

## ■ Audio leveler

The audio leveler monitors the difference in audio levels between input signals from external equipment and minimizes the change in output volume that could occur when switching input signals.

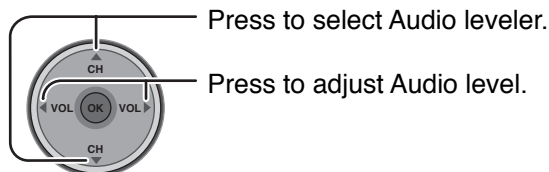

**Note:** Audio leveler is not available when “Speakers” is set to Off.

Other adjust	↩
AI Sound	On
Surround	Off
Speakers	On
HDMI In	Auto
Audio leveler	0

# Sub-Menu Navigation

## Timer

Select Timer to turn the TV on and off at selected times and on selected days. Press the MENU button to display the Main menu.

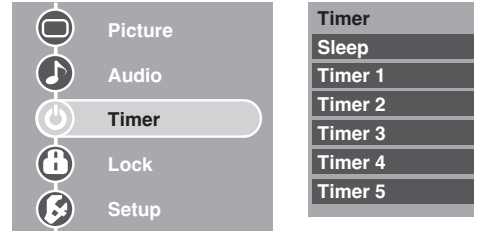
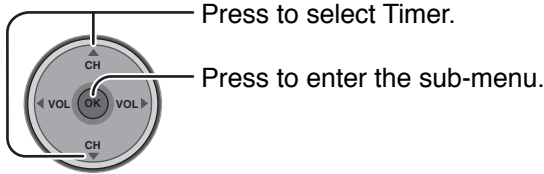

### Sleep timer

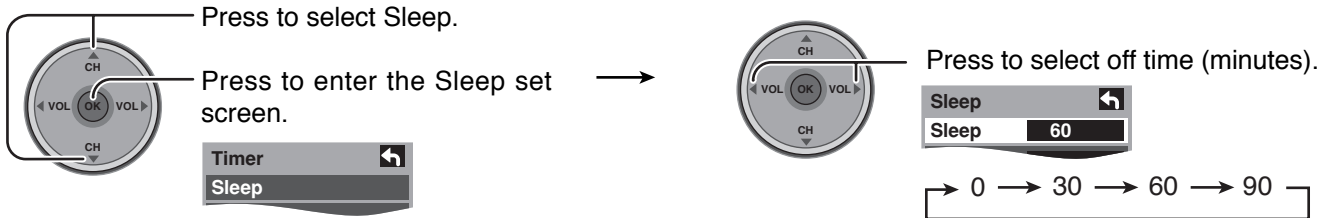

### Timer set

The Clock must be set before On time/Off time settings can be made. (See pages 18-19, 29)

#### Channel

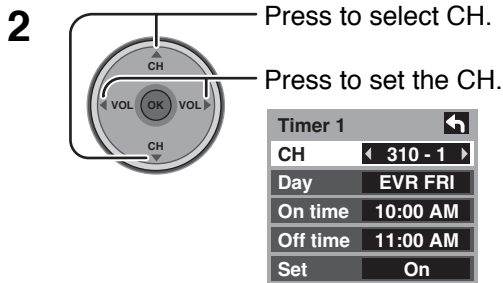
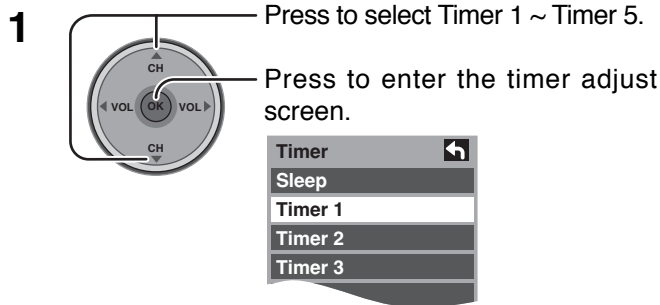

#### Day

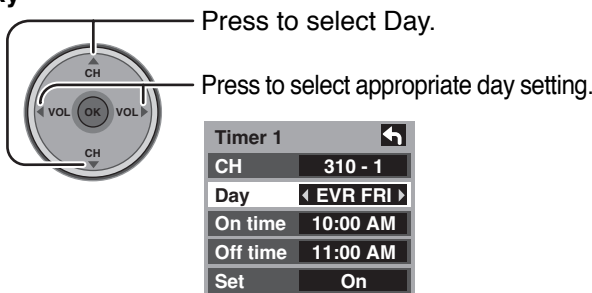

#### Selectable day items

SUN, MON, TUE, WED, THU, FRI, SAT, MON-FRI, SAT-SUN, DAILY, EVR SUN, EVR MON, EVR TUE, EVR WED, EVR THU, EVR FRI, EVR SAT

#### On time / Off time

Perform the following operations for both "On time" and "Off time".

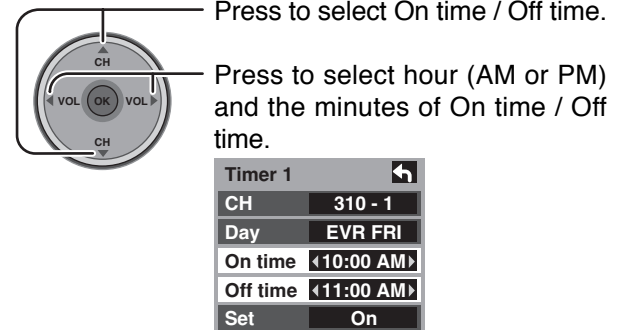

#### Set

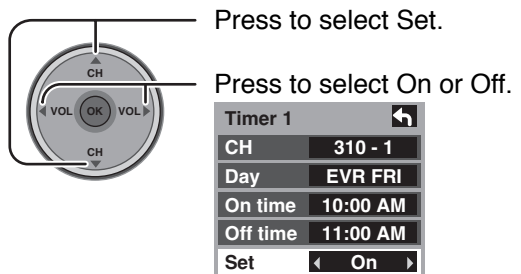

#### Notes:

- The TV automatically turns Off after 90 minutes when turned On by the Timer. This operation will be cancelled if the Off time is selected or if a key is pressed.
- When the power to the TV set is disrupted due to a power outage or similar problem, the off-timer will be deactivated and the TV will be in standby mode even after power is restored.

To return to the previous screen

RETURN  
○ Press to return.

## Set up

Press the MENU button to display the Main menu.

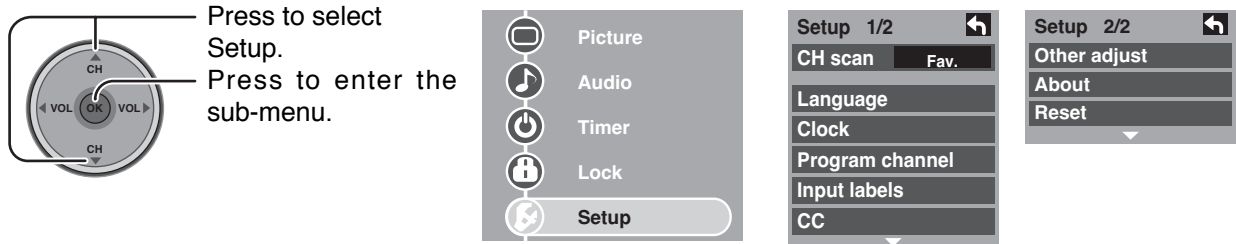

### CH scan

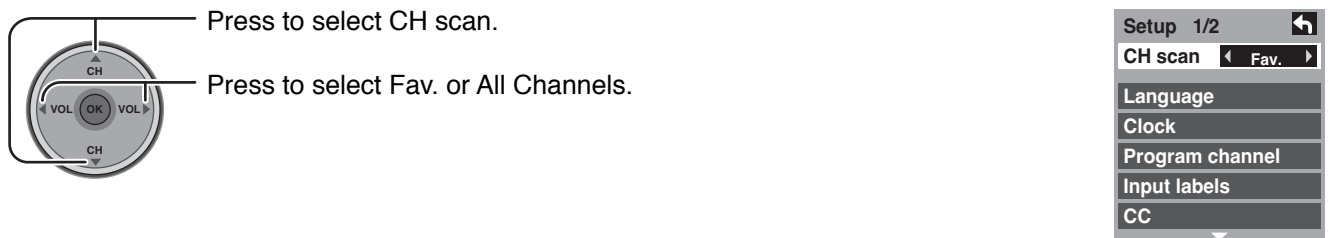

### Language

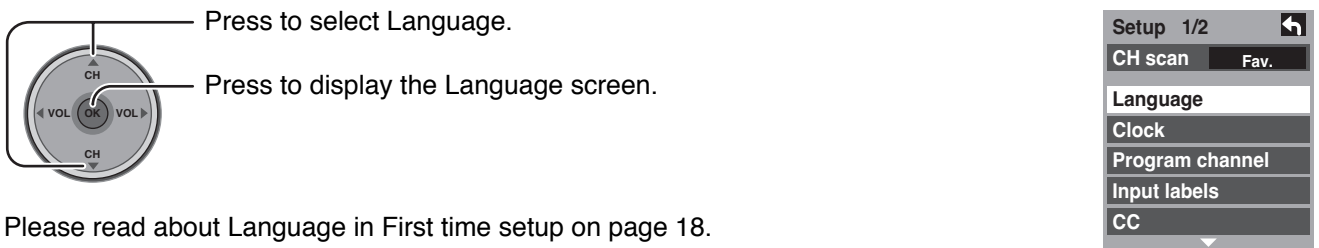

### Clock

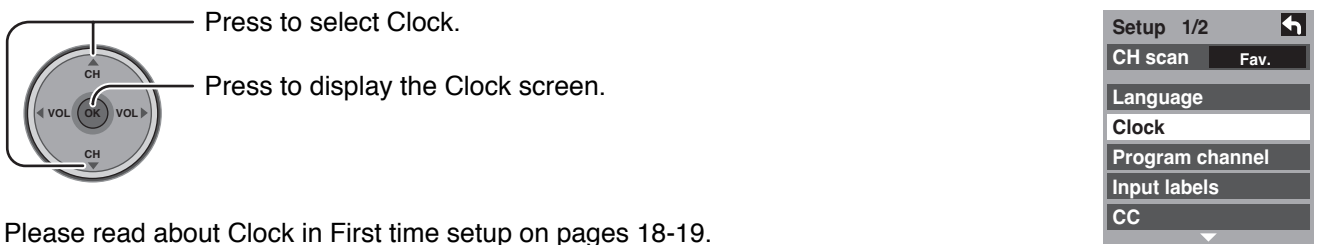

# Sub-Menu Navigation

## Program CH

**1**

Press to select Program channel.  
Press to enter Program channel menu.

Setup 1/2  
CH scan Fav.  
Language  
Clock  
Program channel  
Input labels  
CC

**2**

Press to select sub-menus.  
Press to enter sub-menu.

Program channel  
Auto  
Manual  
Signal meter

### Auto program

Automatically scans all available channels.

**1**

Press to select ANT In.  
Press to select Cable or Antenna.

Auto program  
ANT In Cable  
Mode All  
Start scan

**2**

Press to select Mode.  
Press to select All or Analog.

Auto program  
ANT In Cable  
Mode All  
Start scan

All : Analog and Digital  
Analog : Analog only

**3**

Press to select Start scan.  
Press to start.

Auto program  
ANT In Cable  
Mode All  
Start scan

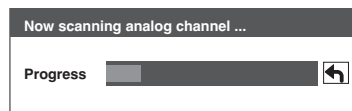

- After Auto program is complete, the unit will return to Manual Program mode.

To make available a channel that has been located by auto scan, in the Manual program mode, move the cursor to [Apply] and press [OK].

### Manual program

To add or delete channels from channels list manually.

Press to select Manual.  
Press to enter the Manual Program screen.

Program channel  
Auto  
Manual  
Signal meter

### Program edit

**1**

Press to select "Edit".  
Press to enter the edit mode.

CH	Caption	Favorite	Add
1	...	...	No
2	...	2	Yes
3	...	...	No
4	...	...	No
5	...	...	No
6	...	...	No
7	...	...	No
8	...	...	No
9	...	...	No
10	...	...	No

**2**

Press to select the desired preset channel line.  
Press to select edit area. Caption, Favorite, Add.  
Press to enter the preset screen. Refer to next page for each adjustment.

RETURN



Press to move cursor to [Apply].



Press to enter your program.

## ● Edit (Caption)

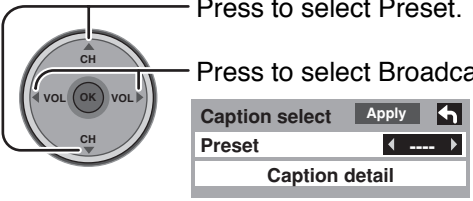
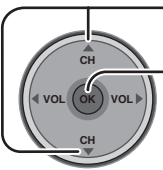
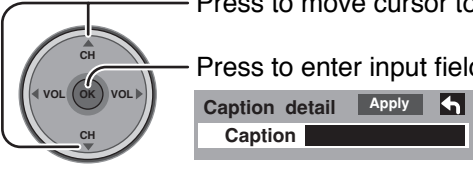
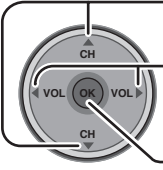
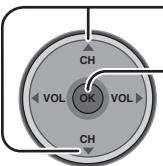
- 1
  - Press to select Preset.
  - Press to select Broadcast st.
- 2
  - Press to select Caption detail.
  - Press to display the Caption input screen.
- 3
  - Press to move cursor to Caption.
  - Press to enter input field.
- 4
  - Press to select the character to input/change.
  - Press to move to the character to input/change.
  - Press to enter your selection.
  - Press to move cursor to Apply.
  - Press to enter the Caption.

## ● Edit (Favorite)

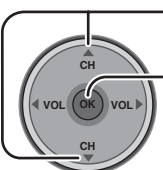
- 1
  - Press to select Favorite.
  - Press to select Favorite number.
- 2
  - Press to move cursor to Apply.
  - Press to enter Favorite and return to Edit screen.

## ● Edit (Add)

Setting of register/delete in Program channel.

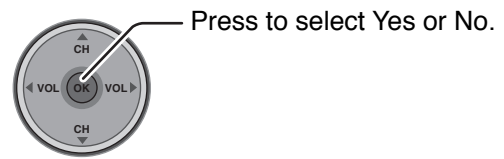

## ■ Signal meter

(For digital channels only)

Displays the signal strength of the ATSC digital channel in Antenna.

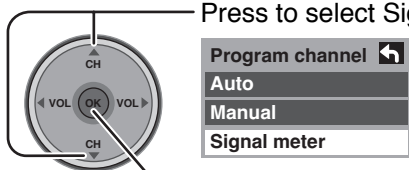
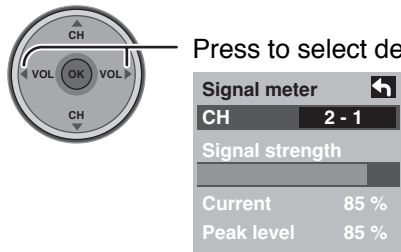
- 1
  - Press to select Signal meter.
  - Press to display signal meter.
- 2
  - Press to select desired channel.

### Note:

- The signal meter works only for digital signals input via the antenna.

# Sub-Menu Navigation

## Input labels

To label video input connections for on-screen display.

1

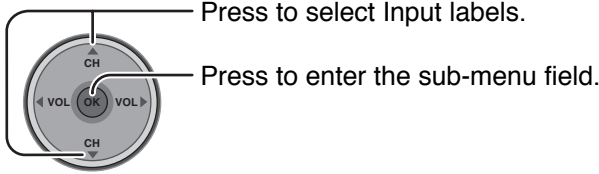

2

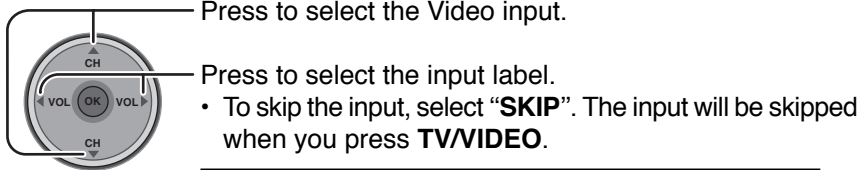

**Selectable input labels :**  
Skip, VCR, DVD, Cable, DBS, PVR, GAME, AUX

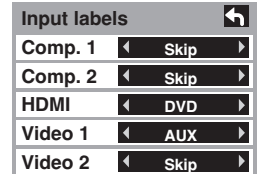
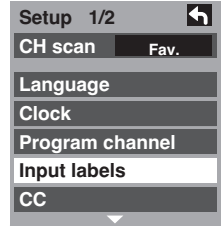

## CC (Closed Caption)

The television includes a built-in decoder that is capable of providing a visual display of the audio portion. The program viewed must provide Closed Captioning (CC) for the television to display it.

### ■ CC Mode

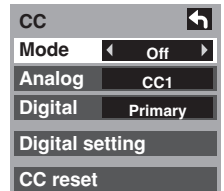
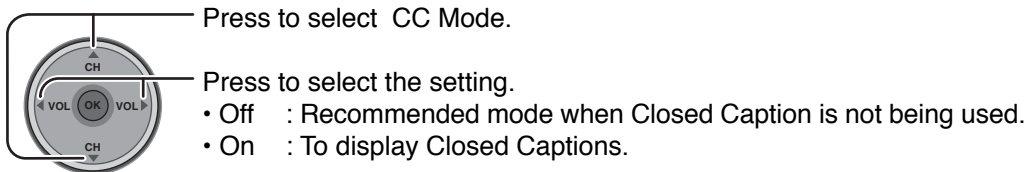

### Notes:

- The closed caption is not displayed when you use HDMI connection.
- If analog connected equipment is used for displaying or recording, closed caption (CC) should be set On/Off on the connected equipment.

The CC mode setting of the TV will not affect the analog input.

If a digital program is being output in analog format, the CC data will also be output in analog format.

If digital connected equipment is used for input, CC should be set On on either the connected equipment or the TV.

If CC is set On on both the connected equipment and the TV, captions from each unit will overlap.

### ■ Analog

Choose the closed caption service of Analog broadcasting.

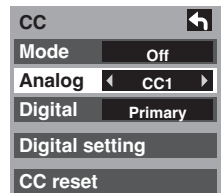
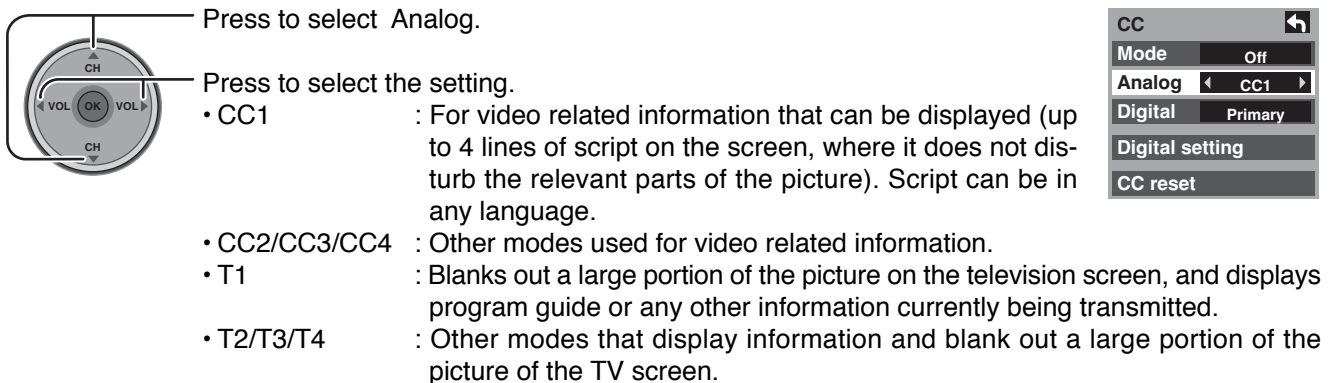



## ■ Digital

The Digital Closed Caption menu lets you configure the way you choose to view the digital captioning.

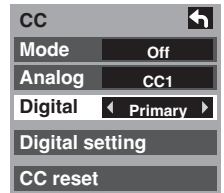
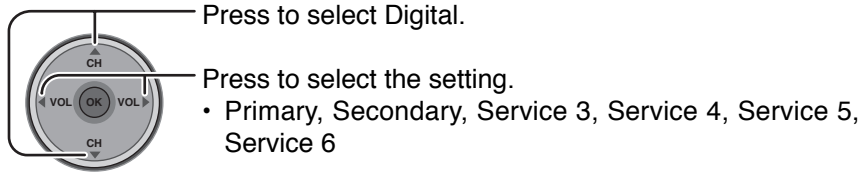

## ■ Digital settings

Selecting digital broadcast service and viewing formats.

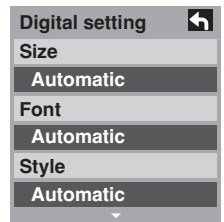
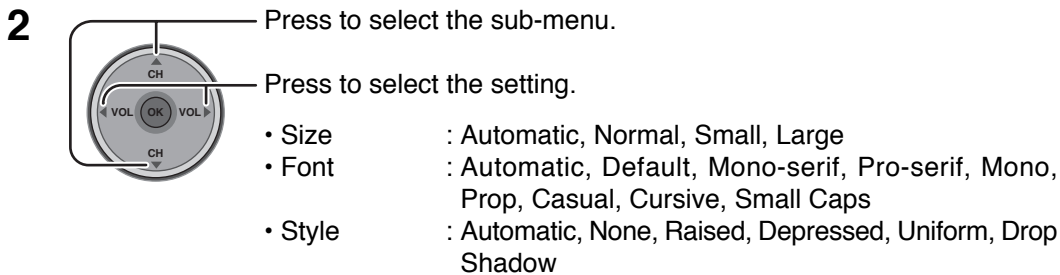
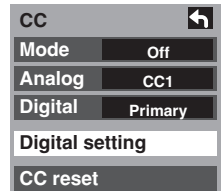
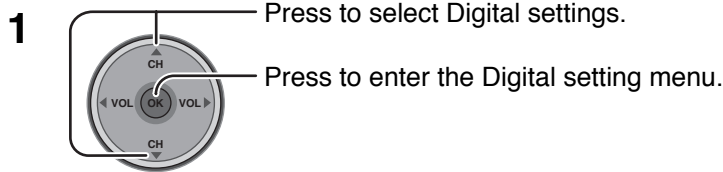

- Foreground : The color of the font (Automatic, Black, White, Red, Green, Blue, Yellow, Magenta, Cyan)
- Fore Opacity : The opacity of the font (Automatic, Transparent, Translucent, Solid, Flashing)
- Background : The color of the text box (Automatic, Black, White, Red, Green, Blue, Yellow, Magenta, Cyan)

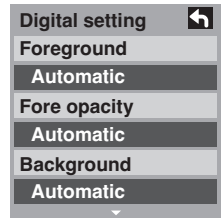

- Back Opacity : The opacity of the text box (Automatic, Transparent, Translucent, Solid, Flashing)
- Outline : The outline of the text (if selected under style)(Automatic, Black, White, Red, Green, Blue, Yellow, Magenta, Cyan)

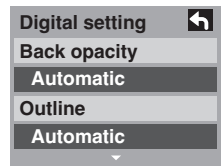

## ■ CC Reset

Reset the CC settings.

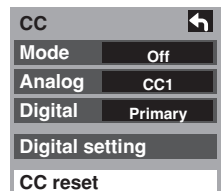
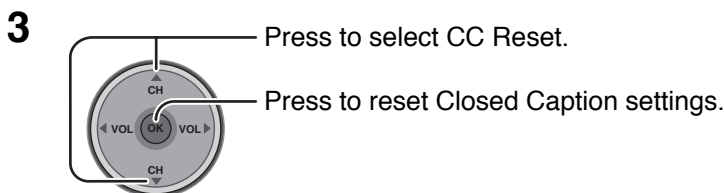

# Sub-Menu Navigation

## Other adjust (Setup)

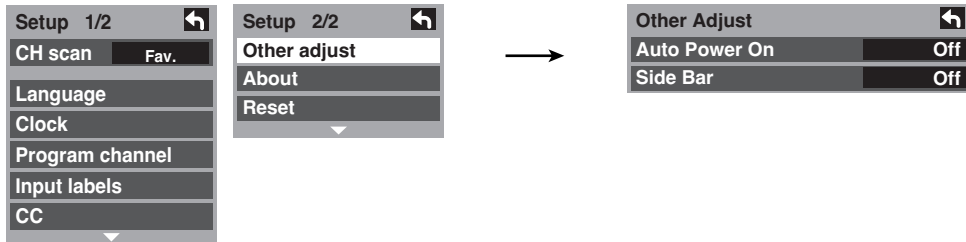

### Auto Power On

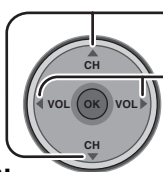

Press to select Auto Power On.

Press to select Set or Off.

Select Set to power on the TV at the same time as the cable box or other connected components.



### Note:

- The Sleep Timer and On / Off timer will not function if Auto Power On is set.

### Side Bar Adjustment

Do not display a picture in 4:3 mode for an extended period, as this can cause an after-image to remain on the side bar on either side of the display field.

To reduce the risk of such an after-image, change the brightness of the side bars.

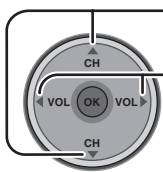
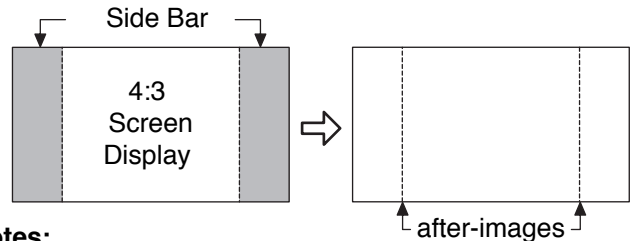

Press to select Side bar.

Press to select Off, Dark, Mid, Bright.



### Notes:

- To reduce the occurrence of after-images, set the Side Bar to Bright.
- The side bar may flash (alternate black/white) depending on the picture. Using Cinema mode will reduce such flashing (see page 24).

## About

Display the TV set Version and Software License.

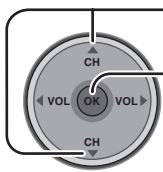

Press to select About.

Press to display the About screen.

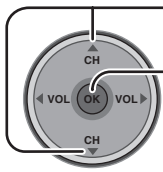

Press to select Version or License.

Press to display Version or License.

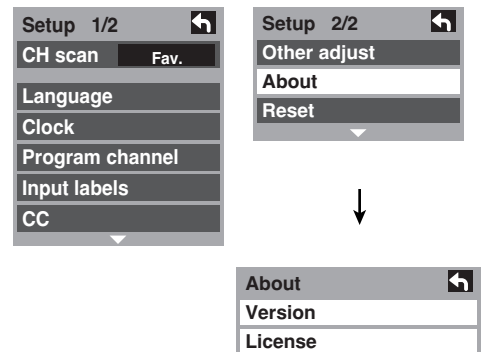

## Reset

Setup is reset.

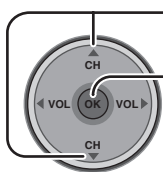

Press to select Reset.

Press to display the password screen.

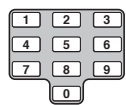

Enter your password by pressing 0 ~ 9 keys to reset the Setup settings.

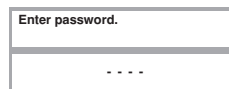

The confirmation screen is displayed. Select "Yes", and press the "OK" key.

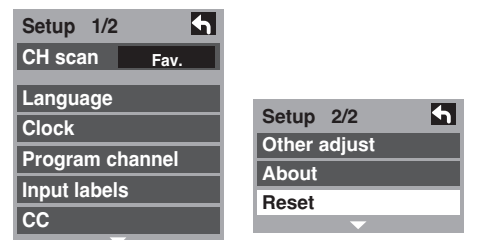

### Note:

- Performing Reset will clear all items set with Setup, such as channel settings. Use Reset with care.

## Lock

Press the MENU button to display the Main menu.

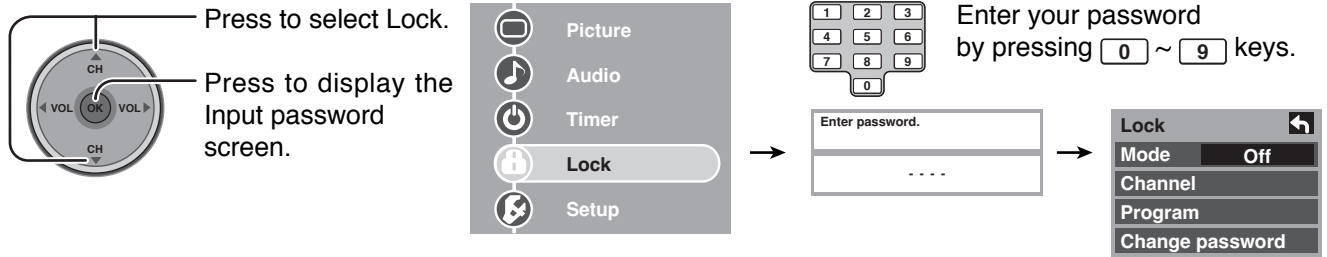

### Lock mode

Select Lock mode to prevent viewing of video games, VCR tapes, channels and Video modes.

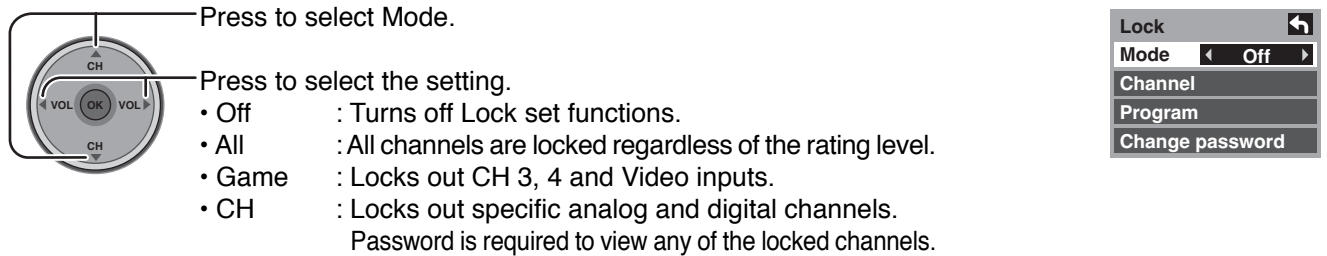

### Channel (Block channel selection)

Select up to 7 (1-7) channels to be blocked out. These channels will be blocked out regardless of the program rating.

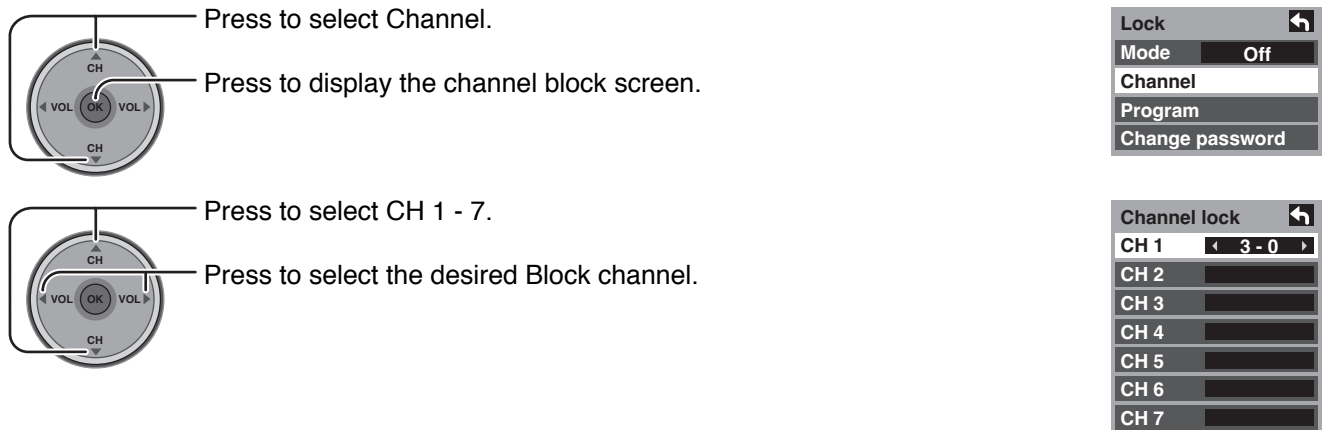

# Sub-Menu Navigation

## Block program

This television incorporates V-Chip technology to block the viewing of movies and television programs according to the rating category. There are four (4) Content Advisory Categories: MPAA (Motion Picture Association of America), U.S.TV Program, Canadian English ratings and Canadian French ratings. These categories are used as guidelines for blocking programs.

- The default mode for the Lock category is the Unlocked state.

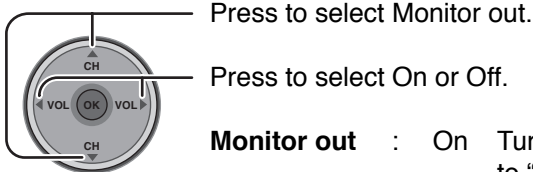
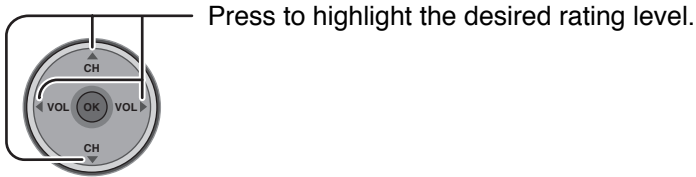
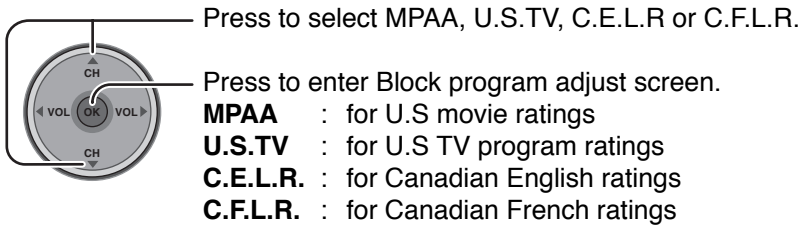
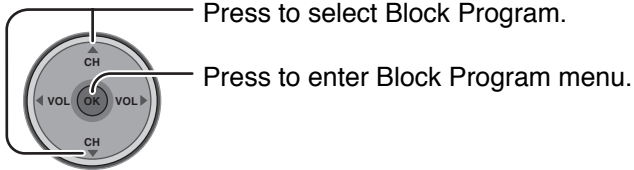

**Monitor out** : On Turns on the monitor terminal output for programs that have been set to "Blocked."  
Off Turns off the monitor terminal output for programs that have been set to "Blocked."

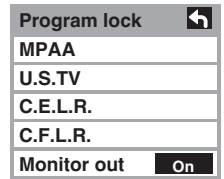
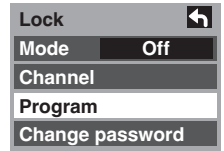

### Notes:

- The Off rating is independent of other ratings.
- When placing a block on a specific age based rating level, the Off rating and any other more restrictive ratings will also be blocked.

## U.S. MOVIES RATINGS CHART

<b>Off</b>	NO RATING (NOT RATED) AND NA (NOT APPLICABLE) PROGRAMS. Movie has not been rated or rating does not apply.
<b>G</b>	GENERAL AUDIENCES. All ages admitted.
<b>PG</b>	PARENTAL GUIDANCE SUGGESTED. Some material may not be suitable for children.
<b>PG-13</b>	PARENTS STRONGLY CAUTIONED. Some material may be inappropriate for children under 13.
<b>R</b>	RESTRICTED. Under 17 requires accompanying parent or adult guardian.
<b>NC-17</b>	NO ONE 17 AND UNDER ADMITTED.
<b>X</b>	ADULTS ONLY.

## U.S. TV PROGRAMS RATINGS CHART

The TV Parental Guidelines has 7 levels of age-based ratings that can be selected. These 7 levels are split into 2 age-based groups:

Youth Age-based Ratings and Guidance Age-based Ratings. Some of these age-based ratings can also have content-based ratings, denoted as D (Dialog), L (Language), S (Sex) and V (Violence). The table below shows the age-based ratings selection.

Age-based Group	Age-based Ratings	Possible Content Selections	Description
NR (Not Rated)	<b>TV-NR</b>	<ul style="list-style-type: none"> <li>• Viewable</li> <li>• Blocked</li> </ul>	Not Rated. See CUSTOMER CAUTION on page 38.
Youth	<b>TV-Y</b>	<ul style="list-style-type: none"> <li>• Viewable</li> <li>• Blocked</li> </ul>	All children. The themes and elements in this program are specifically designed for a very young audience, including children from ages 2-6.
	<b>TV-Y7</b>	<ul style="list-style-type: none"> <li>• FV (Fantasy Violence)</li> <li>• Viewable</li> <li>• Blocked</li> </ul>	Directed to older children. Themes and elements in this program may include mild physical or comedic violence, or may frighten children under the age of 7.
Guidance	<b>TV-G</b>	<ul style="list-style-type: none"> <li>• Viewable</li> <li>• Blocked</li> </ul>	General audience. It contains little or no violence, no strong language, and little or no sexual dialogue or situations.
	<b>TV-PG</b>	<ul style="list-style-type: none"> <li>• D,L,S,V (all selected)</li> <li>• Any combination of D, L, S, V</li> </ul>	Parental guidance suggested. The program may contain infrequent coarse language, limited violence, some suggestive sexual dialogue and situations.
	<b>TV-14</b>	<ul style="list-style-type: none"> <li>• D,L,S,V (all selected)</li> <li>• Any combination of D, L, S, V</li> </ul>	Parents strongly cautioned. This program may contain sophisticated themes, sexual content, strong language and more intense violence.
	<b>TV-MA</b>	<ul style="list-style-type: none"> <li>• L,S,V (all selected)</li> <li>• Any combination of L, S, V</li> </ul>	Mature audiences only. This program may contain mature themes, profane language, graphic violence, and explicit sexual content.
FV : Fantasy/Cartoon Violence. V : Violence S : Sex L : Offensive Language D : Dialogue with sexual content.			

## CANADIAN ENGLISH RATINGS CHART

<b>E</b>	Exempt - Exempt programming includes: news, sports, documentaries and other information programming, talk shows, music videos, and variety programming.
<b>C</b>	Programming intended for children under age 8. No offensive language, nudity or sexual content.
<b>C8+</b>	Programming generally considered acceptable for children 8 years and over. No profanity, nudity or sexual content.
<b>G</b>	General programming, suitable for all audiences.
<b>PG</b>	Parental Guidance suggested. Some material may not be suitable for children.
<b>14+</b>	Programming contains themes or content which may not be suitable for viewers under the age of 14. Parents are strongly cautioned to exercise discretion in permitting viewing by pre-teens and early teens.
<b>18+</b>	18+ years old. Programming restricted to adults. Contains constant violence or scenes of extreme violence.

# Sub-Menu Navigation

## CANADIAN FRENCH RATINGS CHART

<b>E</b>	Exempt - Exempt programming.
<b>G</b>	General - Programming intended for audience of all ages. Contains no violence, or the violence content is minimal or is depicted appropriately.
<b>8 ANS+</b>	8+ General - Not recommended for young children. Programming intended for a broad audience but contains light or occasional violence. Adult supervision recommended.
<b>13ANS+</b>	Programming may not be suitable for children under the age of 13 - Contains either a few violent scenes or one or more sufficiently violent scenes to affect them. Adult supervision strongly suggested.
<b>16ANS+</b>	Programming may not be suitable for children under the age of 16 - Contains frequent scenes of violence or intense violence.
<b>18ANS+</b>	Programming restricted to adults. Contains constant violence or scenes of extreme violence.

### Customer Caution

The V-Chip system that is used in this set is capable of blocking "NR" programs (non rated, not applicable and none) as per FCC Rules Section 15.120(e)(2). If the option of blocking "NR" programs is chosen "unexpected and possibly confusing results may occur, and you may not receive emergency bulletins or any of the following types of programming:"

- Emergency Bulletins (Such as EAS messages, weather warnings and others)
- Locally originated programming • News • Political • Public Service Announcements • Religious • Sports
- Weather

## Blocking Messages

Various Blocking messages are displayed on-screen depending upon the type of blocking you have selected in the Lock menu.

### Note:

Entering the password will override the block condition. However, the ratings selection will be retained.

Message	Possible cause
Game locked.	The [TV/VIDEO] button was pressed when the Game lock had been selected.
Channel Locked.	Tuned to the designated channel when the Channel lock had been selected. Tuned to CH 3 or CH 4 when the Game lock had been selected.
All locked.	Lock all is selected.
Program locked.	Received program that exceeds the Block Program rating level.

## Change password

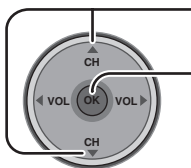

Press to select Change password.  
Press to enter the Input Password screen.

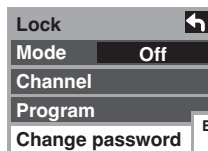

Enter new password.  
.....

Enter new password, again.  
.....

Create a 4-digit password to enter the Lock menu.

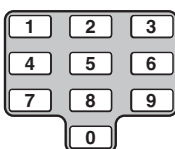

Enter a 4-digit password.

After entering your password for the first time, "New Password" will change to "Enter Password".

### Notes:

- Use a code that is easy to remember and record it in a safe place.
- If you forget your secret code, the TV must be serviced by a qualified technician to clear the Lock setup.

# Operating peripheral equipment

## Programming the remote control code

You can operate other manufacturers' components using this TV's remote control.

### Preparations:

- Connect the power cord of the external component to the wall outlet.
- Make sure the component is turned off.



1



Press and hold **POWER** and **OK** together, for at least **5 seconds**.

- The mode selection buttons flashes, and then release **POWER** and **OK**.

2



Select the type of the component.

- The selected button lights and all others go out.

3

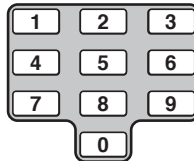

Enter the 3-digit infrared code (see pages 40-42).

- Factory default setting : Panasonic
- Press **POWER** to test the operation.

### Notes:

- If the component does not operate with the remote control, repeat the procedure using another code. (Some brands have multiple codes.)
- If an incorrect code is entered, or if the procedure takes longer than 30 seconds, the programming will fail.

### To find a code not listed in the index

1

After selecting the type of component (step 2, above)



Press to select the code.

- The code starts from the current device.
- Press **POWER** button to test the operation.
- Repeat the steps until the component code is found. It may take many attempts before the correct code is found.

2

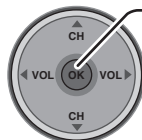

Press to store the code.

# Operating peripheral equipment

## Infrared Code Index

The remote control is capable of operating many brands of peripheral equipment. Refer to page 39 for programming procedures.

### Notes:

- The remote control memory is limited and therefore some models may not be operated. The remote control is not designed to control all features available in all models.
- After entering the proper infrared code, press the desired Mode Selection buttons (see page 16). Refer to pages 43 and 44 for details on operating peripheral equipment using the remote control.

### Infrared Remote Codes for Specific Components

Helpful Hint: Write down the code numbers for your components in the space provided below. This will serve as a handy reference whenever you need to reprogram your remote control.

<b>CABLE</b> Cable Box	<input type="text"/>	<b>VCR</b> Video Cassette Recorder	<input type="text"/>	<b>DVD</b> DVD Recorder / Player	<input type="text"/>
<b>DBS</b> Digital Broadcast System	<input type="text"/>	<b>RCVR</b> Receiver or Amplifier	<input type="text"/>	<b>CD</b> Compact Disc Player	<input type="text"/>
Other Component	<input type="text"/>	Other Component	<input type="text"/>	Other Component	<input type="text"/>
Other Component	<input type="text"/>	Other Component	<input type="text"/>	Other Component	<input type="text"/>

### Codes for VCR

Brand	Code
Admiral	335
Aiwa	332
Akai	314, 315, 316, 329
Audio Dynamic	311, 339
Bell & Howell	305, 313
Broksonic	320, 326
Canon	323, 325
CCE	343
Citizen	306
Craig	305, 306, 329
Curtis Mathes	324, 345
Daewoo	301, 324, 343
DBX	310, 311, 339
Dimensia	345
Emerson	303, 319, 320, 325, 326, 343
Fisher	305, 307, 308, 309, 313
Funai	320, 326, 334
GE	324, 333, 345
Goldstar	306
Gradiente	334
Hitachi	300, 323, 345
Instant Replay	323, 324
Jensen	339
JVC	310, 311, 334, 339
Kenwood	306, 310, 311, 339
LXI	300, 305, 306, 307, 308, 309
Magnavox	323, 324, 331
Marantz	310, 311, 339
Marta	306
Memorex	309, 324
MGA	338, 340, 341, 347, 348
Minolta	300, 345
Mitsubishi	338, 340, 341, 347, 348
Multitech	304, 347
NEC	310, 311, 334, 339
Olympic	323, 324

Brand	Code
Optimus	306, 321, 328, 335
Orion	320, 326
Panasonic	321, 322, 323, 324
Penney	300, 305, 310, 311, 324, 339, 345
Pentax	300, 311, 345
Philco	320, 323, 324, 326, 331, 343
Philips	323, 324, 331
Pioneer	323
Proscan	300, 301, 302, 323, 324, 331, 333, 345, 346
Quasar	321, 322, 323, 324
Radio Shack	305, 309, 324, 333, 336, 340
RCA	300, 301, 302, 323, 324, 331, 333, 345, 346
Realistic	305, 309, 324, 336, 340
Samsung	302, 304, 333
Sansui	320, 326, 339, 352
Sanyo	305, 309, 313
Scott	301, 302, 304, 309, 320, 326, 338, 340, 347, 348
Sears	300, 305, 306, 307, 308
Sharp	335, 336
Shintom	317
Signature 2000	335
Singer	317
Sony	328, 329, 330
Sylvania	323, 324, 331
Tashiro	306
Tatung	310, 311, 339
Teac	310, 311, 339
Technics	321, 322, 323, 324
Teknika	324
Toshiba	301, 346
Vector Research	311
Wards	306, 309, 335, 336, 344
Yamaha	305, 310, 311, 339
Zenith	306, 344



DVD

## Codes for DVD

Brand	Code
Denon	100
Ferguson	101
JVC	109
Mitsubishi	105
Nordmende	101
Panasonic	100
Philips	103
Pioneer	102
RCA	101

Brand	Code
Saba	101
Samsung	110
Sharp	108
Sony	104
Technics	100
Thomson	101
Toshiba	103
Yamaha	100
Zenith	107

DVD

## Codes for CD

Brand	Code
Admiral	226
Aiwa	233, 235
Carver	229
Denon	242
Emerson	239
Fisher	205
Harman Kardon	219, 220, 221, 223
Hitachi	207
Jensen	234
JVC	240, 241, 245
Kardon	223
Kenwood	200, 201, 211, 245
LXI/Sears	236
Magnavox	229, 232
Marantz	229
McIntosh	221
Nakamichi	210
Onkyo	214, 215

Brand	Code
Optimus	208, 218, 220, 222
Panasonic	224, 225, 227
Philips	229, 230
Pioneer	208
Quasar	224, 225, 227
RCA	231, 237, 238, 247
Sansui	210, 246
Sanyo	205
Scott	210, 246
Sharp	242, 243
Sherwood	220
Sony	228
Soundesign	244
Teac	212, 216, 218
Technics	224, 225, 227
Victor	240, 241, 245
Yamaha	202, 203, 204

AUX

## Codes for Personal Video Recorders

Brand	Code
Panasonic Replay TV	100
Philips Tivo	101
Sony Tivo	102

AUX

## Codes for Cassette Deck

Brand	Code
Aiwa	223, 224, 225
Denon	231
Fisher	203
Jensen	214
JVC	229, 230
Kenwood	200, 207
Marantz	202
Nakamichi	205
Onkyo	208, 209, 213
Panasonic	216, 218

Brand	Code
Philips	222
Pioneer	204
RCA	226, 227, 228
Sansui	205, 210
Sharp	231
Sony	219, 220
Teac	210, 211, 215
Technics	216, 218
Yamaha	201, 202

# Operating peripheral equipment

RCVR

## Codes for Receivers

Brand	Code
Admiral	120
Aiwa	125, 126
Denon	134, 135, 136
Fisher	104
Garrard	113
Harman Kardon	115, 123
Jensen	129
JVC	132, 133
Kenwood	100, 108
Magnavox	127
Marantz	124
McIntosh	116
Nakamichi	106
Onkyo	109, 114

Brand	Code
Optimus	103, 127, 130, 131
Panasonic	118, 119, 121
Philips	123
Pioneer	105, 107
Quasar	118, 119, 121
RCA	103, 105, 127, 130, 131
Sansui	103, 111, 139
Sharp	134, 137
Sony	122
Soundesign	138
Teac	111, 112, 113
Technics	118, 119, 121
Victor	132, 133
Yamaha	101, 102

DBS/CBL

## Codes for DBS

Brand	Code
Dish Network	105, 115, 116
Echo Star (EchoStar)	105
Express VU	105, 115
G.E.	106
G.I. (General Instrument)	108
Gradiente	114
Hitachi	103, 111, 112
HNS (Hughes)	103

Brand	Code
Magnavox	101, 102
Panasonic	104
Philips	101, 102
Primestar	108
Proscan	106, 109, 110, 113
RCA	106, 109, 110, 113
Sony	107
Star Choice	103, 108
Toshiba	100
Uniden	101, 102
Zenith	127

DBS/CBL







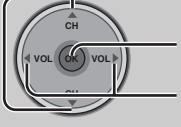

## Codes for Cable Box

Brand	Code
ABC	224
Archer	225, 232
Cableview	205, 232
Citizen	205, 222
Curtis	212, 213
Diamond	224, 225, 232
Eagle	229
Eastern	234
GC Brand	205, 232
Gemini	222
General Instrument/Jerrold	211, 219, 220, 221, 222, 223, 224, 225, 226, 227
Hamlin	212, 218, 240, 241, 242, 245
Hitachi	203, 224
Macom	203, 204, 205
Magnavox	233
Memorex	230
Movietime	205, 232
Oak	202, 237, 239
Panasonic	209, 210, 214
Philips	206, 207, 228, 229, 230
Pioneer	201, 216
Pulsar	205, 232



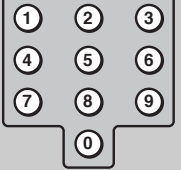











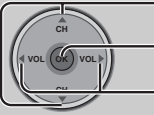

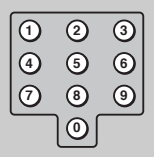

Brand	Code
Puser	232
RCA	215
Realistic	232
Regal	212, 218, 240, 241, 242, 245
Regency	234
Rembrandt	205, 232, 237
Samsung	205
Scientific Atlanta	211, 212, 213
Slmark	201, 205
Sprucer	205, 210
Stargate	205, 232
Teleview	201, 205
Texscan	244
Tocom	235
Toshiba	204
Unika	225, 232
Universal	222, 232
Videoway	206
Viewstar	229, 230
Zenith	200, 217
Zenith /Drake Satellite	200

## Mode Operational Key Chart

This chart defines which keys are operational after programming (if needed), while in the selected remote control mode, DTV, CABLE, DBS, VCR, DVD ...etc.

KEY NAME	DTV MODE	CABLE MODE	DBS MODE
	POWER	POWER	POWER
	NAVIGATION UP/DOWN	CABLE CHANNEL UP/DOWN	DBS NAVIGATION UP/DOWN
	OK	—	DBS MENU
	NAVIGATION RIGHT/LEFT	—	DBS NAVIGATION RIGHT/LEFT
	DTV MENU	—	—
	PROGRAM INFO.	—	DBS PROGRAM INFO.
	EXIT (EPG) ELECTRONIC PROGRAM GUIDE	—	EXIT DBS MENU
	Select Channel	Select Channel	Select Channel
	PREVIOUS STB CHAN	CABLE PREVIOUS CHAN	DBS PREVIOUS CHAN
	DTV PROGRAM/DASH	—	—
	Info (EPG) ELECTRONIC PROGRAM GUIDE	—	—
	—	—	DBS CHANNEL UP/DOWN

# Operating peripheral equipment

KEY NAME	VCR MODE	DVD/CD MODE		AUX MODE			RCVR MODE
		(DVD)	(CD)	(PVR)	(VCR2)	(TAPE)	
	POWER	POWER	POWER	POWER	POWER	POWER	POWER
	TV MUTE	TV MUTE	RCVR MUTE	TV MUTE	RCVR MUTE	RCVR MUTE	RCVR MUTE
	TV INPUT SW	—	—	—	TV INPUT SW	—	RCVR INPUT SW
	—	—	—	—	—	—	REMOTE BUTTONS
	—	NAVIGATION UP/DOWN	NEXT/PREVIOUS TRACK	NAVIGATION UP/DOWN	—	—	TUNER +/-
	—	—	—	—	—	—	—
	VOLUME +/-	NAVIGATION RIGHT/LEFT	RCVR VOLUME +/-	NAVIGATION RIGHT/LEFT	VOLUME +/-	VOLUME +/-	RCVR VOLUME +/-
	—	—	—	PVR MENU	—	—	—
	ONSCREEN VCR DISPLAY	DVD DISPLAY	TIME FORMAT	—	ONSCREEN VCR DISPLAY	—	—
	—	—	—	EXIT PVR MENU	—	—	—
	—	—	—	Select Channel	—	—	1.... AV1 2.... AV2 3.... AV3 4.... AV4 5.... CD 6.... TUNER 7.... PHONO 8.... TAPE 9.... AUX
	—	—	—	PREVIOUS CHAN RELAY ZONES	—	DECK A/B	—
	—	—	—	PVR RETURN TO LIVE	—	—	—
	VCR REW/FF	SKIP SEARCH REW/FF	SEARCH REW/FF	—	VCR REW/FF	TAPE REW/FF	SURROUND -/+
	PLAY	PLAY	PLAY	PLAY	PLAY	PLAY	—
	PAUSE	STILL/PAUSE	PAUSE	PAUSE	PAUSE	PAUSE	—
	STOP	STOP	STOP	—	STOP	STOP	—
	VCR RECORD	—	—	PVR RECORD	VCR RECORD	TAPE RECORD	—
	TV/VCR SWITCH	SLOW +/-	—	—	TV/VCR SWITCH	—	—
	VCR CHANNEL UP/DOWN	—	—	PVR CHANNEL UP/DOWN	VCR CHANNEL UP/DOWN	—	RCVR CENTER +/-
	—	OPEN/CLOSE	OPEN/CLOSE	PVR QUICK SKIP	—	—	—

# VIDEO/COMPONENT/HDMI input signals

## VIDEO input

	signal name	horizontal frequency(kHz)	vertical frequency(Hz)
1	NTSC	15.73	59.94

## Applicable input signals (\* mark)

	signal name	horizontal frequency(kHz)	vertical frequency(Hz)	COMPONENT	HDMI
1	525 (480) /60i	15.73	59.94	*	*
2	525 (480) /60p	31.47	59.94	*	*
3	750 (720) /60p	45.00	60.00	*	*
4	1,125 (1,080) /60i	33.75	59.94	*	*

Note: Signals without above specification may not be displayed properly.

## HDMI input

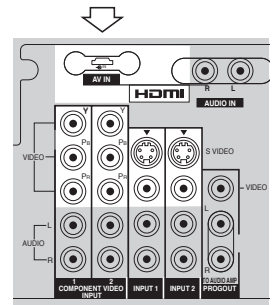

COMPONENT input VIDEO input



















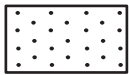



# Specifications

		TH-42PD50																								
<b>Power Source</b>		AC 120 V, 50/60 Hz																								
<b>Power Consumption</b>		Maximum : 390 W Stand-by condition : 0.6 W																								
<b>Plasma Display panel</b>		Drive method : AC type 42-inch , 16 : 9 aspect ratio																								
<b>Screen Size</b>		Approx. 36 <sup>7</sup> / <sub>32</sub> " (920mm) (W) × 20 <sup>25</sup> / <sub>64</sub> " (518 mm) (H) × 41 <sup>37</sup> / <sub>64</sub> " (1056 mm) (diagonal)																								
<b>Dimensions (W × H × D)</b>		Approx. 42 <sup>3</sup> / <sub>64</sub> " (1068 mm) × 27 <sup>39</sup> / <sub>64</sub> " (701 mm) × 3 <sup>51</sup> / <sub>64</sub> " (96.5 mm)																								
<b>Mass (Weight)</b>		72.8 lb. (33.0 kg) Net																								
<b>Channel Capability-ATSC/NTSC</b>		VHF/ UHF : 2-69, CATV:1-135																								
<b>Sound</b>	<b>Speaker</b>	4 <sup>23</sup> / <sub>32</sub> " (120 mm) × 2 <sup>23</sup> / <sub>64</sub> " (60 mm) × 2 pcs 6 Ω																								
	<b>Audio Output</b>	16 W [ 8 W + 8 W ] ( 10 % THD )																								
<b>FEATURES</b>		3D Y/C FILTER CLOSED CAPTION HDMI V-Chip																								
<b>Accessories Supplied</b>		Remote control: EUR7627Z60 AA Battery × 2 AC Cord Pedestal Cable clamber × 2 F-type antenna adapter (5C-2V × 1)																								
<b>Operating Conditions</b>		Temperature : 34 °F - 104 °F (0 ° - 40 °C) Humidity : 20 % - 80 % (non-condensing)																								
<b>Connection Terminals</b>		<table border="0"> <tr> <td>AV INPUT 1- 2</td> <td>VIDEO (Phono Jack Type)</td> <td>1.0 Vp-p (75 Ω)</td> </tr> <tr> <td></td> <td>S-VIDEO (Mini DIN 4-pin)</td> <td>Y : 1.0 Vp-p (75 Ω), C : 0.286 Vp-p (75 Ω)</td> </tr> <tr> <td></td> <td>AUDIO L-R (Phono Jack Type × 2)</td> <td>0.5 Vrms</td> </tr> <tr> <td>AV PROG. OUT</td> <td>VIDEO (Phono Jack Type)</td> <td>1.0 Vp-p (75 Ω)</td> </tr> <tr> <td></td> <td>AUDIO L-R (Phono Jack Type × 2)</td> <td>0.5 Vrms</td> </tr> <tr> <td>COMPONENT VIDEO INPUT1-2</td> <td>Y P<sub>B</sub> / P<sub>R</sub> AUDIO L-R (Phono Jack Type × 2)</td> <td>1.0 Vp-p (including synchronization) ± 0.35 Vp-p 0.5 Vrms</td> </tr> <tr> <td>HDMI</td> <td>HDMI type A Connector AUDIO L-R (Phono Jack Type × 2)</td> <td>0.5 Vrms</td> </tr> <tr> <td>DIGITAL AUDIO OUT</td> <td>PCM / Dolby Digital, Fiber Optic</td> <td></td> </tr> </table>	AV INPUT 1- 2	VIDEO (Phono Jack Type)	1.0 Vp-p (75 Ω)		S-VIDEO (Mini DIN 4-pin)	Y : 1.0 Vp-p (75 Ω), C : 0.286 Vp-p (75 Ω)		AUDIO L-R (Phono Jack Type × 2)	0.5 Vrms	AV PROG. OUT	VIDEO (Phono Jack Type)	1.0 Vp-p (75 Ω)		AUDIO L-R (Phono Jack Type × 2)	0.5 Vrms	COMPONENT VIDEO INPUT1-2	Y P <sub>B</sub> / P <sub>R</sub> AUDIO L-R (Phono Jack Type × 2)	1.0 Vp-p (including synchronization) ± 0.35 Vp-p 0.5 Vrms	HDMI	HDMI type A Connector AUDIO L-R (Phono Jack Type × 2)	0.5 Vrms	DIGITAL AUDIO OUT	PCM / Dolby Digital, Fiber Optic	
AV INPUT 1- 2	VIDEO (Phono Jack Type)	1.0 Vp-p (75 Ω)																								
	S-VIDEO (Mini DIN 4-pin)	Y : 1.0 Vp-p (75 Ω), C : 0.286 Vp-p (75 Ω)																								
	AUDIO L-R (Phono Jack Type × 2)	0.5 Vrms																								
AV PROG. OUT	VIDEO (Phono Jack Type)	1.0 Vp-p (75 Ω)																								
	AUDIO L-R (Phono Jack Type × 2)	0.5 Vrms																								
COMPONENT VIDEO INPUT1-2	Y P <sub>B</sub> / P <sub>R</sub> AUDIO L-R (Phono Jack Type × 2)	1.0 Vp-p (including synchronization) ± 0.35 Vp-p 0.5 Vrms																								
HDMI	HDMI type A Connector AUDIO L-R (Phono Jack Type × 2)	0.5 Vrms																								
DIGITAL AUDIO OUT	PCM / Dolby Digital, Fiber Optic																									

Note: Design and Specifications are subject to change without notice. Weight and Dimensions shown are approximate.

# Troubleshooting Chart

Before calling for service, determine the symptoms and follow suggested solutions.

Symptoms		Solutions	Page
VIDEO	AUDIO		
 Snowy Video	 Noisy Audio	<ul style="list-style-type: none"> <li>Adjust the antenna location and connection.</li> </ul>	11
 Multiple Image	 Noisy Audio	<ul style="list-style-type: none"> <li>Adjust the antenna location and connection.</li> <li>Check the antenna lead-in cable.</li> </ul>	11 11
 Interference	 Noisy Audio	<ul style="list-style-type: none"> <li>Move the television away from electrical appliances, lights, vehicles and medical equipment.</li> </ul>	—
 Normal Video	 No Audio	<ul style="list-style-type: none"> <li>Increase volume</li> <li>Check Mute.</li> <li>Check Television Speakers on/off.</li> <li>Change channel.</li> <li>Stereo/SAP/Mono</li> <li>When using HDMI</li> </ul>	20 17 27 20 17 27
 No Video with Snow	 Noisy Audio	<ul style="list-style-type: none"> <li>Set Input Setup properly.</li> <li>Check the antenna cables.</li> </ul>	30 11
 No Video	 No Audio	<ul style="list-style-type: none"> <li>Check if the power cord is plugged into the wall outlet.</li> <li>Adjust Brightness and Audio controls.</li> <li>Change channel.</li> <li>Check the cable connections.</li> <li>Program the remote control code.</li> <li>Check the second video source operation.</li> <li>Make sure that a PC is not connected to HDMI input. Rarely, the TV will not display video in HDMI input from devices with HDMI or DVI output due to bad communication between the TV and the devices. Should this happen, unplug the HDMI/DVI device and plug it back in.</li> </ul>	15 24,26,27 20, 22 10-14 39-42 39-44 12
 No Color	 Normal Audio	<ul style="list-style-type: none"> <li>Adjust Color settings.</li> <li>Change channel.</li> </ul>	24, 25 20
 Digitalization of image Image freeze up	 Audio Break up	<ul style="list-style-type: none"> <li>Re-orient the ATSC antenna.</li> <li>Check signal meter. If the signal is weak, add a signal booster to boost the signal strength.</li> </ul>	— 31
 Normal Video	 Wrong Audio	<ul style="list-style-type: none"> <li>Check if the audio mode is set to Stereo or Mono, not SAP.</li> <li>Change the audio of the HDMI device to Linear PCM.</li> <li>Check the audio setting for HDMI. If there is functional problem with Digital Audio, use Analog audio.</li> </ul>	17 — 27
 Black Box on Screen	 Normal Audio	<ul style="list-style-type: none"> <li>Change CC (Closed Caption).</li> <li>Change the Closed Caption (CC) Analog settings to other than T1, T2, T3 or T4.</li> </ul>	32
 Normal Video	 Normal Audio	<ul style="list-style-type: none"> <li>Replace the remote control batteries.</li> </ul>	8
Intermittent Remote Control Operation			

## Plasma Display panel

Symptoms	Check	Page
Some parts of the screen do not light up.	<ul style="list-style-type: none"> <li>The plasma display panel is manufactured using an extremely high level of precision technology; however, sometimes some parts of the screen may be missing picture elements or have luminous spots. This is not a malfunction.</li> </ul>	—
<div style="text-align: center;">  <p>An after-image appears.</p> </div>	<ul style="list-style-type: none"> <li>Do not allow a still picture to be displayed for an extended period, as this can cause a permanent after-image to remain on the Plasma TV. Examples of still pictures include logos, video games, computer images, teletext and images displayed in 4:3 mode.</li> </ul> <p><b>Note:</b> The permanent after-image on the Plasma TV resulting from fixed image use is not an operating defect and as such is not covered by the Warranty. This product is not designed to display fixed images for extended periods of time.</p>	34

# CUSTOMER SERVICES DIRECTORY (for U.S.A.)

## *Customer Services Directory*

Obtain Product Information and Operating Assistance; locate your nearest Dealer or Servicer; purchase Parts and Accessories; or make Customer Service and Literature requests by visiting our Web Site at:  
**<http://www.panasonic.com/consumersupport>**

or, contact us via the web at:  
**<http://www.panasonic.com/contactinfo>**

You may also contact us directly at:  
1-888-VIEW-PTV (843-9788)  
Monday-Friday 9 am-9 pm; Saturday-Sunday 10 am-7 pm, EST.

For hearing or speech impaired TTY users, TTY : 1-877-833-8855

## *Accessory Purchases*

Purchase Parts, Accessories and Instruction Books on line for all Panasonic Products by visiting our Web Site at:  
**<http://www.pasc.panasonic.com>**

or, send your request by E-mail to:  
**[npcparts@us.panasonic.com](mailto:npcparts@us.panasonic.com)**

You may also contact us directly at:  
1-800-332-5368 (Phone) 1-800-237-9080 (Fax Only) (Monday - Friday 9 am to 8 pm, EST.)  
Panasonic Services Company  
20421 84th Avenue South,  
Kent, WA 98032  
(We Accept Visa, MasterCard, Discover Card, American Express, and Personal Checks)

For hearing or speech impaired TTY users, TTY : 1-866-605-1277

## *Service in Puerto Rico*

Panasonic Puerto Rico, Inc.  
Ave. 65 de Infantería, Km. 9.5, San Gabriel Industrial Park,  
Carolina, Puerto Rico 00985  
Phone (787)750-4300, Fax (787)768-2910

**Customer's Record**

The model number and serial number of this product can be found on its back cover. You should note this serial number in the space provided below and retain this book, plus your purchase receipt, as a permanent record of your purchase to aid in identification in the event of theft or loss, and for Warranty Service purposes.

Model Number \_\_\_\_\_

Serial Number \_\_\_\_\_

---

**Panasonic Consumer Electronics  
Company,  
Division of Panasonic Corporation  
of North America**  
One Panasonic Way Secaucus  
New Jersey 07094 U.S.A.

**Panasonic Puerto Rico Inc.  
("PSC")**  
Ave. 65 de Infanteria, Km 9.5  
San Gabriel Industrial Park,  
Carolina, Puerto Rico 00985

**Panasonic Canada Inc.**  
5770 Ambler Drive  
Mississauga, Ontario  
L4W 2T3 CANADA